

Technical note: A low cost, automatic soil-plant-atmosphere enclosure system to investigate CO₂ and ET flux dynamics.

Wael Al Hamwi^{1,3}, Maren Dubbert¹, Jörg Schaller^{2,3}, Matthias Lück¹, Marten Schmidt¹,
Mathias Hoffmann¹

5 ¹Isotope Biogeochemistry and Gas Fluxes, Leibniz-Center for Agricultural Landscape Research (ZALF),
Müncheberg, 15374, Germany.

²Silicon Biogeochemistry, Leibniz-Center for Agricultural Landscape Research (ZALF), Müncheberg, 15374,
Germany.

10 ³Department of Agricultural Sciences, Nutritional Sciences, and Environmental Management, University of
Giessen, 35390, Giessen, Germany.

Correspondence to: Wael Al Hamwi (Wael.Alhamwi@zalf.de)

Abstract

Investigating Greenhouse Gases (GHG) and water flux dynamics within the soil-plant-atmosphere-interphase is
15 a key for understanding ecosystem functioning, as they reflect the ecosystem's responses to environmental
changes. Understanding these responses is essential for developing sustainable agricultural systems that can help
to adapt to global challenges such as inter-alia increased drought. Typically, an initial understanding of GHG and
water flux dynamics is gained through laboratory or Greenhouse pot experiments, where gas exchange is often
20 measured using commercially available, manual closed (leaf) chamber systems. However, these systems are rather
expensive and often labor-intensive, thus limiting the number of different treatments and their repetitions that can
be studied. Here, we present a fully automatic, low cost (<1.000 Euro per unit), multi-chamber system based on
Arduino, termed "Greenhouse Coffins". It is designed to continuously measure canopy CO₂ and
evapotranspiration (ET) fluxes. It can operate in two modes: an independent and a dependent measurement mode.
The independent measurement mode utilizes low cost NDIR CO₂ (K30 FR) and relative humidity (SHT31)
25 sensors, thus making each "Greenhouse Coffin" a fully independent measurement device. The dependent
measurement mode connects multiple "Greenhouse Coffins" via a low cost Multiplexer (< 250 Euro) to a single
infrared gas analyzer (LI-850, LI-COR Inc., Lincoln, USA), allowing for measurements in series, achieving cost
efficiency, while also gaining more flexibility in terms of target GHG fluxes (potential extension to N₂O, CH₄,
stable isotopes). In both modes, CO₂ and ET fluxes are determined through the respective concentration increase
30 during closure time. We tested both modes and demonstrated that the presented system is able to deliver precise
and accurate CO₂ and ET flux measurements using low cost sensors, with an emphasis on calibrating the sensors
to improve measurement precision. Through connecting multiple Greenhouse Coffins via our low cost Multiplexer
to a single infrared gas analyzer in the dependent mode, we could show moreover that the system can efficiently
35 measure CO₂ and ET fluxes in a high temporal resolution across various treatments with both labor and cost
efficiency. Therefore, the developed system offers to be a valuable tool for conducting Greenhouse experiments,
enabling comprehensive testing of plant-soil dynamic responses to various treatments and conditions.

1. Introduction

Agricultural systems are particularly vulnerable to the more frequent, less predictable extreme weather events (e.g. droughts, heat waves) wrought by climate change (Altieri et al. 2015; Ummenhofer and Meehl 2017).
40 Moreover, agricultural systems have the potential to both contribute to (Tubiello et al. 2013; Chataut et al. 2023) and mitigate (Lal 2004; Powlson et al. 2016) Greenhouse Gas (GHG) emissions, influenced by the practices implemented and the specific environmental contexts in which they operate. Therefore, to best mitigate the challenges of extreme weather (especially drought and heat waves) and to characterize the potential of agricultural fields to decrease or even reverse GHG emissions, it is essential to better monitor (and thus understand) gas and
45 water fluxes between those systems and the atmosphere (Zhang et al. 2002; Joshua B. Fisher et al. 2017).

Chamber-based systems (automatic or manual) in conjunction with high temporal resolution gas analyzers are one of the most common techniques for directly measuring CO₂ and evapotranspiration (ET), providing precise data on a leaf to plot scale and allowing to assess small scale heterogeneity (Smith et al. 2010; Dubbert et al. 2014; Riederer et al. 2014). However, it is challenging to study the effects of climate change on agricultural GHG
50 dynamics given the difficulties inherent to both field-based and laboratory based research on soil-plant-atmosphere systems. Field based research comes at the expense of high variability, environmental noise and the labor and cost associated with large-scale, high-resolution data collection and equipment, whereas lab-based research is limited by a lack of environmental context and replicability beside the high cost of equipment both share (Savage and Davidson 2003, Sun, X. et al. 2013; Martin et al. 2017; Blackstock et al. 2019). Mesocosm-
55 scale experiments performed in greenhouses or climate controlled chambers, allow researchers to mimic the in situ environmental conditions of many different settings, and provide the opportunity to variably manipulate those conditions. In this way, researchers can explore the impacts of precisely isolated environmental treatments, bridging the gap between lab-based studies of single plants and field-based studies, thus facilitating a more nuanced understanding of ecological dynamics. (Riebesell et al. 2013; Stewart et al. 2013).

In recent years, researchers have been increasingly developing low cost devices for chamber-based gas-exchange systems using a do-it-yourself (DIY) approach. These DIY systems reduce the generally high cost per device (Fisher and Gould 2012; D'Ausilio 2012), allowing for higher replicability than has been previously possible using commercial systems. They leverage affordable microcontrollers and sensors to build custom measurement tools designed for specific research needs. By integrating sensors for CO₂ and/or ET with microcontrollers,
60 researchers were able to develop portable, precise, and cost-effective devices for monitoring CO₂ and ET fluxes, such as Macagga et al. (2024) and Bonilla-Cordova et al. (2024). Others went a step further and developed fully automated measurement systems to determine CO₂ efflux, such as the "Fluxbots" (Forbes et al. 2023).

To expand the application space of such DIY devices to the mesocosm scale, we have developed and validated the "Greenhouse Coffins", a novel low cost automatic soil-plant enclosure system, designed to monitor CO₂ and
70 ET fluxes within Greenhouse experiments in a fully automatic manner. We hypothesize that 1) a single "Greenhouse Coffin" employing low cost sensors can measure CO₂ and ET fluxes accurately and reliably, comparable to a high-cost gas analyzer. 2) By combining several "Greenhouse Coffins" and adding a low cost self-constructed Multiplexer, we are able to monitor gas fluxes via one infrared gas analyzer for different treatments cost-efficiently. To test these hypotheses, we performed a number of experiments validating the
75 different components of the Greenhouse Coffins. Additionally, we evaluated the accuracy and precision of used

low cost NDIR CO₂ and Relative humidity (RH) sensors (independent mode) by comparing there with measured CO₂ and ET fluxes with those obtained using a commercial infrared gas analyzer(LI-850, LI-COR Inc., Lincoln, USA). Furthermore, we tested the DIY, low cost Multiplexer’s ability to link multiple Greenhouse Coffins to one commercial gas analyzer (dependent mode).

80 2. Material and methods

2.1. Hard and software implementation

The “Greenhouse Coffins” system consists of one to multiple enclosed transparent chambers (PVC; 180x40x60 cm) that can house an entire soil-plant-atmosphere system (Fig. 1). Each chamber can be accessed through a front door sealed using a rubber rope. The front door is equipped with a sliding window mechanism, which is opened
85 and closed by a linear actuator moving it along guiding rails. The sliding window covers two openings, behind which two opposing directed 9V axial fans are installed with a volumetric flow rate of 76.4 m³/h, allowing for a complete air exchange within 20 seconds during the opening period. Ventilation within each chamber is enabled through two additional axial fans at the bottom and top of the door. Each chamber is operated individually by a control unit consisting of a microcontroller (ATmega 328-Board) with an attached logger shield module. This
90 module is equipped with an SD card reader and a 2 GB SD card for data storage, along with a real-time clock (RTC), ensuring accurate timekeeping while off power. A Bluetooth module is connected to the microcontroller for direct operation and data monitoring of the microcontroller using e.g., a smartphone via Serial Bluetooth application. To steer the opening and closure of the sliding window, the microcontroller switches a double relay, which is connected to the linear actuator (Fig. 2). During the closure of the sliding door, the two axial fans behind
95 it are switched off via a Mosfet (IRLZ44N) connected to two resistors (200 and 10000 Ω). The power supply for each Greenhouse Coffin system is provided by a 9 V charger, connected to the microcontroller and axial fans, as well as a linear actuator (requiring 12 V) through a DC-DC buck boost power converter. The control unit is fitted in an outdoor waterproof sealed box (19x12x5 cm) in the top-right corner of the door. When operated independently (independent mode), each Greenhouse Coffin utilizes a low cost NDIR-based CO₂ (0-5000 ppm, ±30 ppm ±3 % accuracy; K30 FR, Senseair AB, Sweden) and an air humidity and temperature sensor (SHT31, ±2% accuracy, Sensirion AG, Switzerland) placed on the inner side of the door (Macagga et al. 2024).
100

The individual “Coffins” (independent mode) can be operated together by connecting multiple Greenhouse Coffins with a low cost Multiplexer unit (dependent mode). This Multiplexer unit switches a series of normally closed solenoid valves acting as air inlets and outlets, thus enabling researchers to chain each Greenhouse Coffin
105 together and connect them to a single gas analyzer. The Multiplexer is controlled by a microcontroller (ATmega-2560), which steers a 16-fold relay model. Each of the 16 relays is linked to two solenoid valves, which open and close the air inlet and outlet of a Greenhouse Coffin. Relays are operated in series. When a relay is powered up, the normally closed solenoid valves connected to it open, connecting the Greenhouse Coffin to the gas analyzer in a closed loop. A voltage sensor connecting the two solenoid valves and the control unit of the Greenhouse
110 Coffin, signals when the solenoid valves are open, so that the sliding door is closed to conduct the measurement, thus enabling an indirect communication and synchronization between the Multiplexer and each attached “Greenhouse Coffin”. The specific “Greenhouse Coffin” being measured at a moment, is indicated by an LCD display connected to the microcontroller of the Multiplexer unit. A Bluetooth module (HC-05) allows for easy data access. To enable remote access to the system during 24/7 measurements, a second Bluetooth module

115 connected to a microcontroller (ATmega 328-Board) with a logger shield acts as an uplink station. When
connected to a stationary PC with internet access, incoming data transferred between both Bluetooth modules can
be accessed on time using a remote access software (e.g., Anydesk). The power supply for the 16-fold relay is
provided by a 12 V charger, connected to a Boost converter step up/down (HW-140 DC-DC), adjusting the energy
to 9 V for the microcontroller. Figure 3 shows the assembled connection of the different components. Detailed
120 information on component prices and distributors for both modes can be found in Table 1. The software was
developed using Arduino IDE 2.0.0.

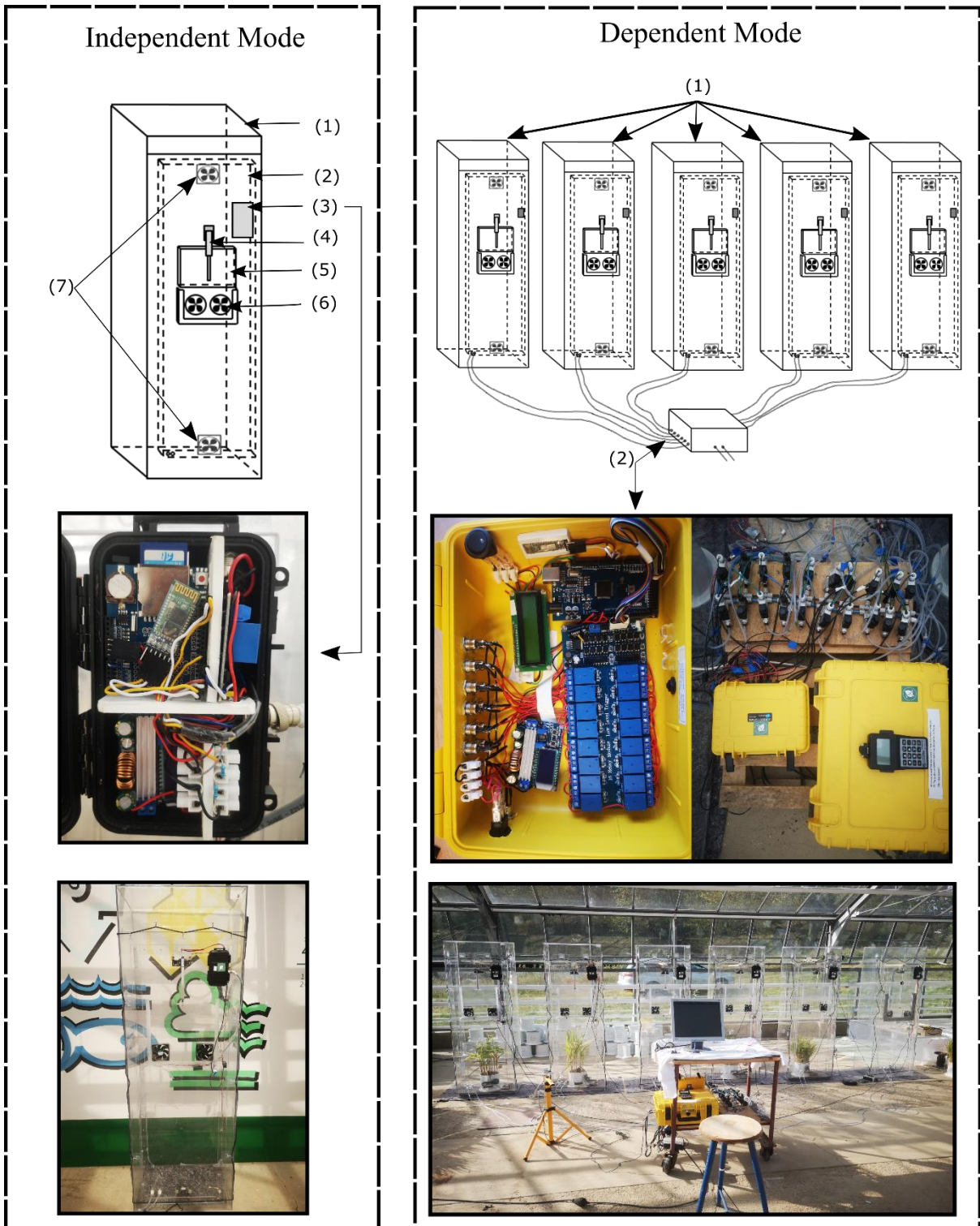

Figure 1: sketch illustrating the Greenhouse Coffins system. (left) The independent mode, a single unit comprises (1) the chamber, (2) the front door, (3) the control unit, (4) the linear actuator, (5) the sliding door, (6) ventilation fans, and (7) air mixing fans. (right) the dependent mode consists of (1) multiple Greenhouse Coffins and (2) a low cost Multiplexer connected to a single gas analyzer.

Table 1 Components needed to construct one “Greenhouse Coffin” and a Multiplexer, respectively. The prices are based on orders placed on July 30, 2023.

	Component	Description	Amount	Price €	Distributor
Greenhouse Coffin	Chamber body	The design was done by the authors, the customized build of the PVC construction (180x40x60 cm) was realized via the company Romid.	1	600	www.romid.pl
	ATmega328-Board	Microcontroller board (clone) similar to the Arduino Uno .	1	3.11	www.az-delivery.de
	Datalogger module XD-204	Datalogger shield with SD card reader and Real-time clock unit.	1	1.14	
	Boost converters step up/down (HW-140 DC-DC)	Used to step up (increase) or step down (decrease) voltage levels in accordance with needs of different components.	1	5	
	2-Relay module 5V	Used to switch devices on and off, reverse voltage for linear actuator.	1	3	
	Bluetooth module (HC-05) Wireless RF-Transceiver module RS232	Bluetooth module for wireless communication and data transmission.	1	4.99	
	Outdoor box (170*110*48 mm)	Outdoor case for housing electrical components.	1	13.98	www.amazon.de
	Hard foam plate 5mm	Material to create the interior of the outdoor box.	1	1	
	0.5 mm ² /20 awg electrical wire,7 colors	Electrical wires to connect different components.	1	2.5	
	Luster terminals	Used to connect wires.	8	0.07	
	Mosfet (IRLZ44N model)	Used to switch voltage on/off.	1	0.79	
	Resistors (10k Ω and 200 Ω)	Used to control the current flow to the Mosfet.	1	0.01	
	SD MEMORY CARD (2 GB.10 MB/s)	Used to store collected data.	1	6	
	8 pin aviation connectors	To connect sensors inside the Coffin with control unit.	1	1.46	
	Power jack socket	To connect an external power supply.	2	1.49	
	8 Core cable (1 m)	A cable to connect the control unit with the fans and sensors inside the chamber.	1	3.5	
	Rubber rope (1.5 m)	Used to secure the front door of the chamber, ensuring a tight sealing.	1	0.73	
	Self-adhesive hooks	Hooks are attached to the chamber and front door to allow tight sealing together with the rubber rope.	20	0.41	
	NDIR CO ₂ sensor (Senseair k30 FR)	A high-performance CO ₂ sensor module with a fast response time (<2 seconds) and range of (0-5000) ppm.	1	85	www.senseair.com
	RH and temperature sensor (SHT31 type)	Air temperature and relative humidity sensor.	1	6.42	www.aliexpress.com
DC12V linear actuator	A linear actuator (90N, 150mm, LA-YR type) to open/close the sliding door.	1	19.50		
Power supply 9v adapter	To provide power to electronic devices and circuits.	1	9.10	www.reichelt.de	
Axial fan (92x92x25mm, 12V)	Axial fan (76.4 m ³ /h) used for headspace air mixing and ventilation.	4	3		
	Sum			791.97	

Multiplexer	16-channel relay module 12V	Used to switch pneumatic solenoid valves on/off.	1	10	www.az-delivery.de
	Boost converters step up/down (HW-140 DC-DC)	Used to step up (increase) or step down (decrease) voltage levels in accordance with needs of different components.	1	5	
	Bluetooth module (HC-05) Wireless RF-Transceiver module RS232	Bluetooth module for wireless communication and data transmission.	2	4.99	
	ATmega328-Board	Microcontroller board (clone) similar to Arduino uno but more cost effective.	1	3.11	
	ATmega2560-Board	Microcontroller board (clone) similar to the Arduino Mega.	1	9.09	
	LCD display with I2C interface	Showing which Coffin is measured	1	5.49	
	Datalogger module XD-204	Datalogger shield with SD card reader and Real-time clock unit.	1	1.14	www.amazone.de
	B&W outdoor case typ1000	Outdoor case for housing electrical components.	1	39.74	
	Voltage detection sensor	To detect electrical voltage levels of attached solenoid valves, allowing for indirect communication between the Coffin control unit and the Multiplexer.	1	1	
	Power switch	To manually switch on/off the entire system.	2	0.8	
	Power jack socket	To connect external power supply to electronic devices and circuits.	13	1.49	
	2 ports 1/4 normally closed pneumatic control valve	Pneumatic solenoid valve for regulating airflow.	12	9.49	
	0.5 mm2/20 awg electrical wire,7 colors	Electrical wires to connect different components.	1	2.5	
	Power supply 12V adapter	Providing power supply to electronic devices and circuits.	1	9.38	
	Sum			222.18	

130

135

140

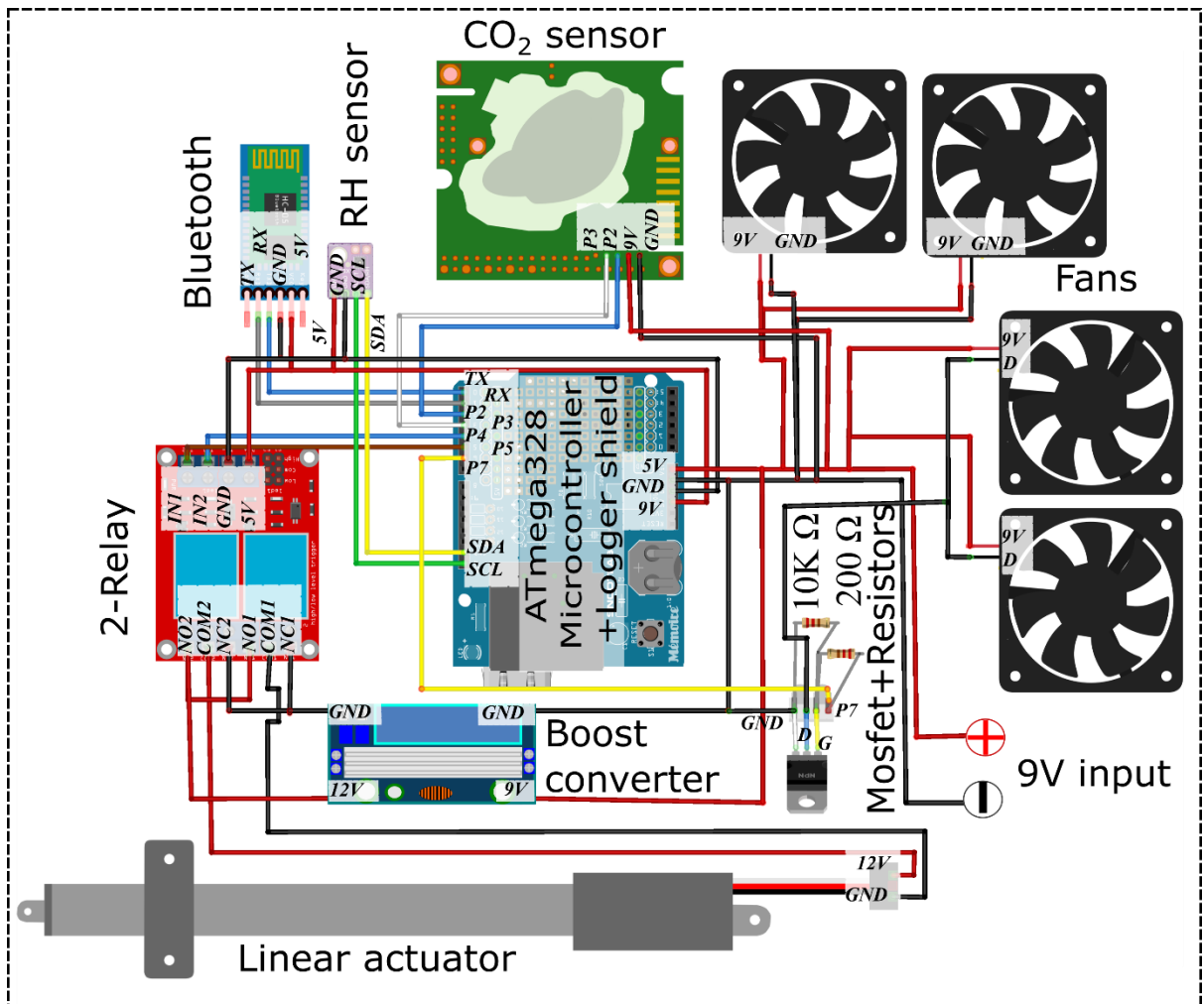
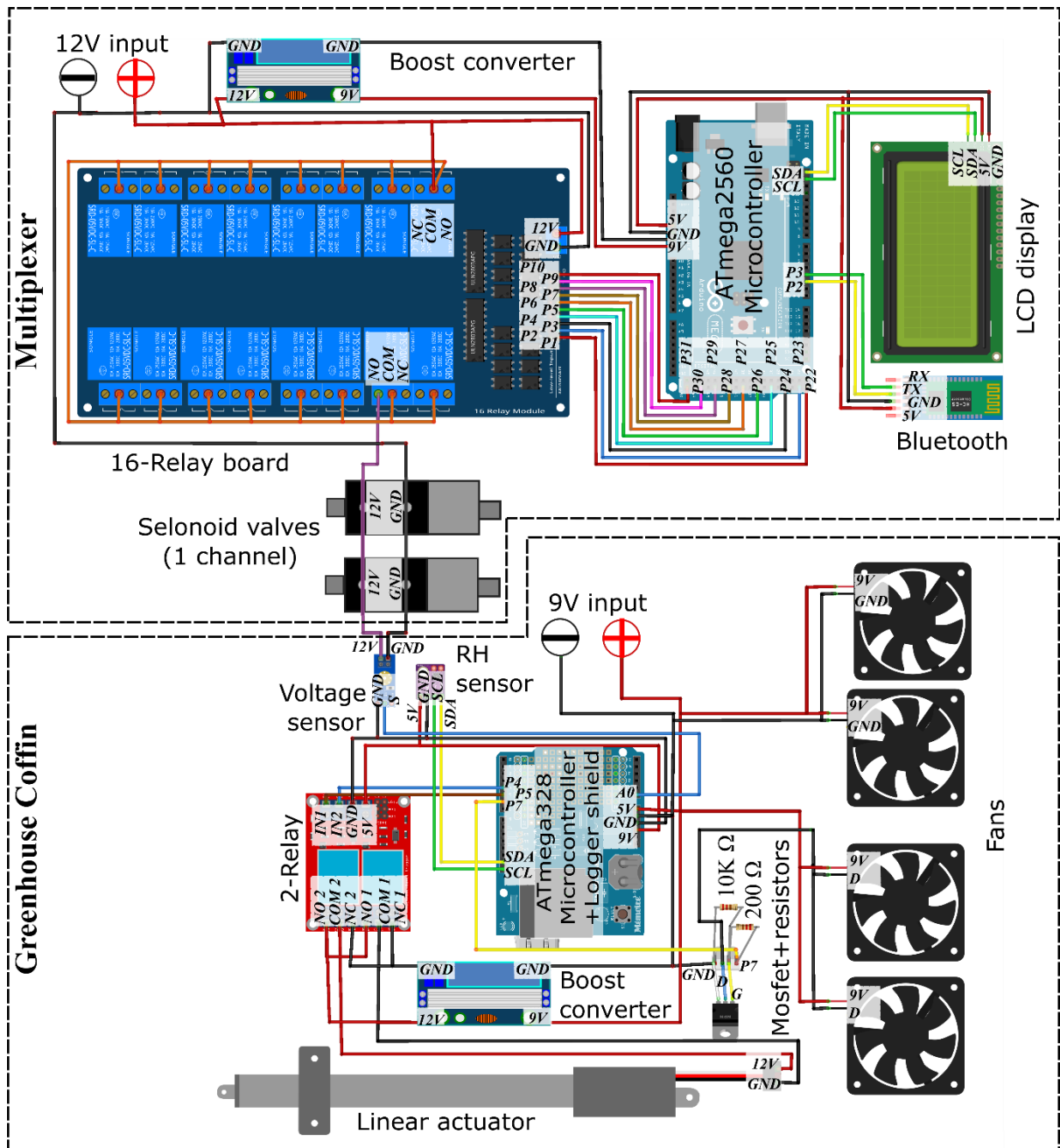

Figure 2 Schematic representation of the wiring of one Greenhouse Coffin in the dependent mode.

145

150



155 **Figure 3 Schematic representation of the wiring of the Multiplexer (on the top) connected to one**
Greenhouse Coffin (on the bottom) in the independent mode.

2.2. Sealing test

We performed three sealing tests to check for any leakage from different system components. Sealing tests included evaluation of : 1.) the sealing of the entire Coffin with door (check for serious leakages in the construction), 2.) the suitability of the sliding window to sufficiently seal the Greenhouse Coffin when closed and exchange air when open, 3.) the proper sealing of the solenoid valves of the Multiplexer.

160

To assess for serious leakages from the Greenhouse Coffin construction itself (more importantly where precisely on the construction it occurs), we used a smoke bomb as suggested by (Hoffmann et al. 2018). The same method was also implemented by (Olfs et al. 2018) for the leakage test on their chamber design used to measure nitrous oxide emissions. We placed the smoke bomb inside the Greenhouse Coffin and lit it. Subsequently, the Greenhouse Coffin was closed for a 15 minute observation period. During this time, any escaping smoke would indicate

165

potential leakage. To check for the suitability of the sliding window to sufficiently seal the Greenhouse Coffin airtight when closed and exchange air when open in its final setup (complete hardware implementation), we repeatedly injected distinct amounts of technical gas containing 1,000,000 ppm CO₂ ranging from 15 to 450 ml
170 into its sealed headspace using a syringe. By connecting an infrared CO₂ gas analyzer (LI-850, LI-COR Inc., Lincoln, USA) to the inlet and outlet of the sealed Greenhouse Coffin, the CO₂ concentration change from before to after injection (ΔCO_2 in ppm) was subsequently measured. The calculated mixing ratio should match the measured CO₂ if the system is properly sealed. Any significant variation would indicate a leak.

To assess the absence of cross-contamination within the dependent mode, out of the six Greenhouse Coffins
175 connected to the CO₂ gas analyzer (LI-820, LI-COR Inc., Lincoln, USA) through the solenoid valves for the inlets and outlets, five were each equipped with plants changing the headspace CO₂ concentration during measurements while one remained empty. We measured then this empty system and checked for potential CO₂ concentration changes. We repeated these measurements for each of the six connected Greenhouse Coffins, altering Coffins filled with plants.

180 2.3. Validation experiment

For the independent mode, we conducted a Greenhouse experiment to test the accuracy of the low cost sensors (K30 FR and SHT31) and the capability of the Greenhouse Coffins system. Therefore, we placed two pots planted with Sorghum inside a Greenhouse Coffin. For non-stop 5 days with a 30-minute chamber closure frequency and 5 min chamber closure time, we measured the CO₂ and ET fluxes using both low cost sensors (K30 FR and SHT31)
185 and an infrared gas analyzer (LI-850, LI-COR Inc., Lincoln, USA), resulting in ~48 CO₂ and ~48 ET fluxes per day.

For the dependent mode, to test the ability of the system to continuously monitor CO₂ and ET fluxes across various treatments in a fully automated manner using a single gas analyzer, we connected six Greenhouse Coffins (two empty, two with Sorghum plants, and two with Maize plants) to a single infrared gas analyzer (LI-850, LI-COR
190 Inc., Lincoln, USA) via the low cost Multiplexer. Subsequently, we measured the CO₂ and ET fluxes for each of the six chambers. Similarly to the independent mode, we measured non-stop 5 days with a 30 minute chamber closure frequency and 5 minute chamber closure time, resulting in ~48 CO₂ and ~48 ET fluxes per day and Greenhouse Coffin. We obtained the environmental variables inside the Greenhouse (air temperature, relative humidity, and photosynthetically active radiation (PAR)) from the Greenhouse's climate station.

195 2.4. Data processing

2.4.1. CO₂ and ET calculations

The first and last 10% of each CO₂ and ET measurement were removed to exclude any potential noises from turbulence and pressure fluctuations during the closing and opening of the sliding window (Hoffmann et al. 2015). Additionally, the CO₂ concentrations measured with the LI-850 were corrected for changes in water vapor concentration during each chamber measurement (correction for dilution by foreign gas; Webb et al. 1980; Hupp, J. et al. 2011) Eq.(1):
200

$$C_g^{wr} = C_g^{ws} \frac{1-w_r/1000}{1-w_s/1000} \quad (1)$$

Where C_g^{wr} is the mole fraction of CO₂ in the sample ($\mu\text{mol/mol}$) corrected to the water vapor content of the reference measurement w_r (mmol/mol), C_g^{ws} is the mole fraction of CO₂ measured in the sample ($\mu\text{mol/mol}$), and

205 w_s is the water vapor content in the sample (mmol/mol). To calculate ET fluxes using the low cost RH sensor (SHT31), measured RH needed to be converted to mass concentration following Hamel et al. (2015) Eq. (2) :

$$H_2O = \frac{RH \cdot e^s}{100 \cdot P}, \quad (2)$$

Where RH is relative humidity, e^s is saturated vapor pressure calculated according to (Allen et al. 1998), and P is gas pressure (Pa). ModularR scripts, as described by (Hoffmann et al. 2015) for CO₂ and (Dahlmann et al. 2023) for ET, were used to calculate CO₂ and ET fluxes measured during the validation experiment. CO₂ and ET fluxes were calculated using the ideal gas law and using a linear regression approach Eq. (3):

$$f = \frac{M \cdot p \cdot V}{R \cdot T \cdot A} \cdot \frac{\Delta c}{\Delta t}, \quad (3)$$

Where M is the molar mass of the gas (g mol⁻¹), p is the ambient air pressure (Pa), V is the chamber volume (m³), R is the gas constant (8.314 m³ Pa K⁻¹ mol⁻¹), T is the temperature inside the chamber (K), A is the basal area (m²), and $\Delta c/\Delta t$ represents the linear concentration changes in CO₂ (e.g., Leiber-Sauheitl et al., 2014) and H₂O over time (e.g., Dahlmann et al., 2023). A variable moving window (window size 0.5 to 5 min) was applied to each chamber measurement to obtain the variables T and $\Delta c/\Delta t$. Accordingly, resulting multiple ET and CO₂ fluxes per measurement (using the generated variable moving window data subset) were evaluated based on specific criteria, including fulfilled prerequisites for applying a linear regression (normality (Lilliefors adaption of the Kolmogorov–Smirnov test), homoscedasticity (Breusch–Pagan test) and linearity), (2) regression slope ($p \leq 0.1$, *t*-test), (3) range of within-chamber air temperature not larger than ± 1.5 K and a PAR deviation (only for day measurements) not larger than ± 20 % of the average to ensure stable environmental conditions within the chamber throughout the respective measurement window, and (4) no outliers present (± 6 times the interquartile range (IRQ)). Calculated CO₂ and ET fluxes meeting all criteria were retained. In cases where multiple fluxes per measurement met all criteria, the CO₂ and ET fluxes with the steepest slope and closest timing to chamber closure were selected.

2.4.2. Statistical analysis

The statistical analysis was done using Scipy and Sklearn packages in Python (version 3.9.12). To determine the suitable statistic test for the collected data during the laboratory validation and Greenhouse trial, a Kolmogorov-Smirnov test ($p < 0.05$) to assess the normal distribution was carried out. A pairwise Wilcoxon signed-rank was employed to determine the significance of the CO₂ and ET fluxes measured by the low cost NDIR sensor and LI-850 sensor, as well as to determine the significance of the CO₂ concentration measured during the cross-contamination test. A concordance correlation coefficient was employed to determine the accuracy of the low cost sensors, while the precision was determined by Root mean square error (RMSE) and Pearson correlation. The error calculation for CO₂ fluxes was quantified using a comprehensive error prediction algorithm described in detail by (Hoffmann et al. 2015) using R software (version 3.6.1). The approaches utilize bootstrapping alongside *k*-fold subsampling to estimate uncertainties for each flux measurement and subsequent R_{eco} and GPP parameterization. This approach was adapted to calculate the error for ET fluxes by (Dahlmann et al. 2023).

3. Results and Discussion

240 3.1. Sealing test

During our smoke bomb test, no visible leakage was detected, indicating the absence of serious leaks from both the Greenhouse Coffin and the sliding window in the Coffin's door. However, a properly sealed Coffin does not

mean that its ventilation system is also sufficient. For repeated measurements, it is essential to replace the chamber headspace air after each measurement, thus recreating atmospheric starting CO₂ and H₂O concentrations. To test
245 for this, we compared the CO₂ starting concentrations (n=38) obtained during the gas injection test. With an average of 413 ± 12 ppm, the CO₂ starting concentrations were not only close to the atmospheric CO₂ concentration (419.3 ppm, NOAA, 2023) but also showed a minor variation, with a minimum and maximum CO₂ starting concentration of 378 ppm and 425 ppm, respectively. Additionally, no significant difference (pairwise Wilcoxon signed-rank, $p > 0.01$) between Δ CO₂ measured by the LI-850 and the calculated mixing ratio was
250 observed (Fig.4). Hence, the gas injection test evidenced the Coffin ventilation system's effectiveness and overall airtightness when used in independent mode. While the Coffins are properly sealed, insufficient solenoid valve closure could lead to cross-contamination, with concentration increases in one Coffin affecting another. Therefore, the cross-contamination test was performed to test for proper sealing of the Coffins and the connected Multiplexer when used in dependent mode. In case of no cross-contamination, an empty Coffin should show no concentration
255 change during its measurement, irrespective of plants being present in the other Coffins connected to the Multiplexer. When comparing the measured Δ CO₂ concentration of the performed cross-contamination, no significant difference to 0 was found (pairwise Wilcoxon signed-rank test, $p > 0.05$). These results show that no cross-contamination due to the Multiplexer occurred within the independent mode. However, since solenoid valves have moving parts that can show wear and tear with long-term use, it is recommended to repeat the cross-
260 contamination test periodically and change the non-tight valve.

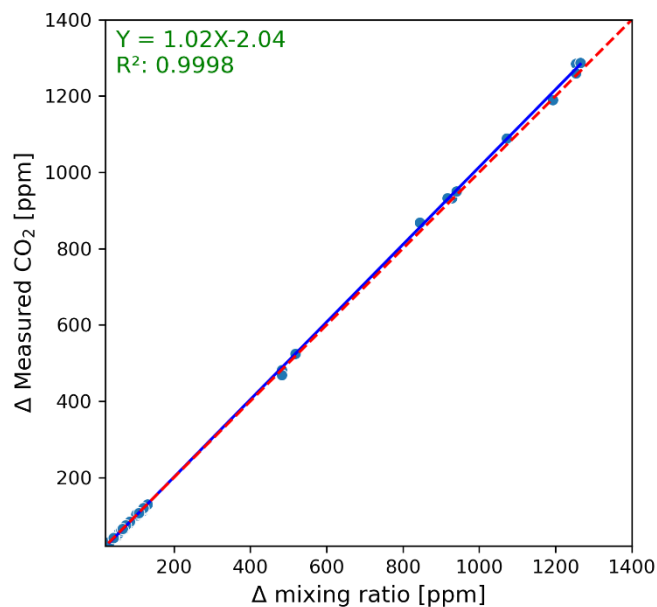

Figure 4:1:1 agreement between the mixing ratio and the measured Δ CO₂ concentration change expressed as in ppm, was obtained during the laboratory validation.

3.2. Validation experiment

3.2.1. Independent mode

265 The validation experiment, performed continuously over five days using a single Greenhouse Coffin in independent mode, demonstrated that CO₂ and ET fluxes can be measured reliably and accurately in a fully automated chamber using low-cost sensors. Out of 223 conducted automatic measurements, more than 99% passed the flux calculation algorithm for CO₂ and ET, respectively. A rate only slightly below the 100% of CO₂ and ET fluxes passing flux calculation when using the LI-850 for CO₂ and H₂O concentration measurements. The

270 low cost as well as LI-850 derived CO₂ and ET fluxes showed mainly identical diurnal pattern, with low fluxes during nighttime and higher ET fluxes and a strong CO₂ uptake during daytime (Fig.5). Observed diurnal pattern, clearly followed monitored environmental parameters with higher ET fluxes and CO₂ uptake with higher PAR and a higher R_{eco} (nighttime measurements) with higher air temperatures. Figure 6 shows the 1:1 agreement and correlation between a) calculated CO₂ and b) ET fluxes based on low cost and LI-850 measurements of CO₂ and
275 H₂O concentrations as well as RH. The overall accuracy of both low cost sensors derived CO₂ and ET fluxes is indicated by the high concordance correlation coefficient of 0.98 and 0.98 for CO₂ and ET, respectively. These results align well with the findings of (Macagga et al. 2024), who tested the accuracy and suitability of the same sensors for in-situ manual closed chamber measurements and suggested a high degree of precision (scatter of measurement) and trueness (proximity to the true value) of used low cost sensors. Also, other studies highlighted
280 the precision and trueness of the K30 FR and SHT31 sensors (Ali et al. 2016; Martin et al. 2017; Cannon et al. 2022). This is so far important, as a low trueness level can result in significant deviations from the actual value, while low precision can introduce noise/scatter into flux measurements (Werle 2011) and might hamper the repeatability of measurement results. However, while an RMSE of 5.05 $\mu\text{mol m}^{-2} \text{s}^{-1}$ and 2.84 mm d^{-1} , and Pearson correlation coefficient of 0.99 and 0.98 proved the high precision for CO₂ and ET measured within this study,
285 respectively, this was not equally the case for the trueness. On the one hand, calculated fluxes derived from CO₂ concentration and RH measurements using the low cost sensors correlated nearly perfectly (R²: 0.98) with CO₂ and ET fluxes calculated based on LI-850 measurements of CO₂ and H₂O concentrations (Fig. 6). On the other hand, a clear underestimation in the case of higher CO₂ uptake by plants and ET flux rates for the low cost sensors is evident in Fig. 6. This is confirmed by conducted pairwise Wilcoxon signed-rank tests, which resulted in
290 significant differences between fluxes calculated based on measurements with the K30 FR, SHT31 and LI-850 sensor, respectively ($p < 0.05$).

This underestimation, while potentially relevant for calculating fluxes, was not detected in other studies such as inter-alia (Macagga et al. 2024), which is likely due to the considerably larger observation range in this study, when compared to previous studies (Ali et al. 2016; Cannon et al. 2022; Macagga et al. 2024). For example,
295 Macagga et al. (2024) report a flux range of -17.05 to 13.74 $\mu\text{mol m}^{-2} \text{s}^{-1}$ For CO₂ and 1.2 to 3.0 mm d^{-1} for H₂O, while in our study, the CO₂ and ET flux amplitude was up to six times higher with CO₂ and ET fluxes ranging from -89.06 to 15.37 $\mu\text{mol m}^{-2} \text{s}^{-1}$ and 0.7 to 18.66 mm d^{-1} , respectively. Since the underestimation was much more pronounced at higher CO₂ uptake and ET, the trueness for the flux range of 20 to -30 $\mu\text{mol m}^{-2} \text{s}^{-1}$ for CO₂ and range of 0 to 5 mm d^{-1} was hence, comparable with findings of Macagga et al. (2024). This highlights the
300 importance to assess sensor performance for a wide range of concentrations during validation experiments when aiming to use low cost sensors and the independent mode to obtain accurate results. Especially in case of CO₂, these experiments should not only consider conditions above but also below ambient. However, the precision of the used low cost sensors throughout the entire flux measurement range for CO₂ as well as ET enabled us to derive and apply a correction function. After applying the correction function (CO₂: $Y=1.11X-1.46$, ET: $Y=1.08X+0.04$)
305 on low cost sensor-based CO₂ and ET fluxes, cumulated CO₂ and ET fluxes for the 5 day validation experiment period (e.g., 5 day flux balance), derived using low cost and LI-850 measurements, differed by < 1.5 %.

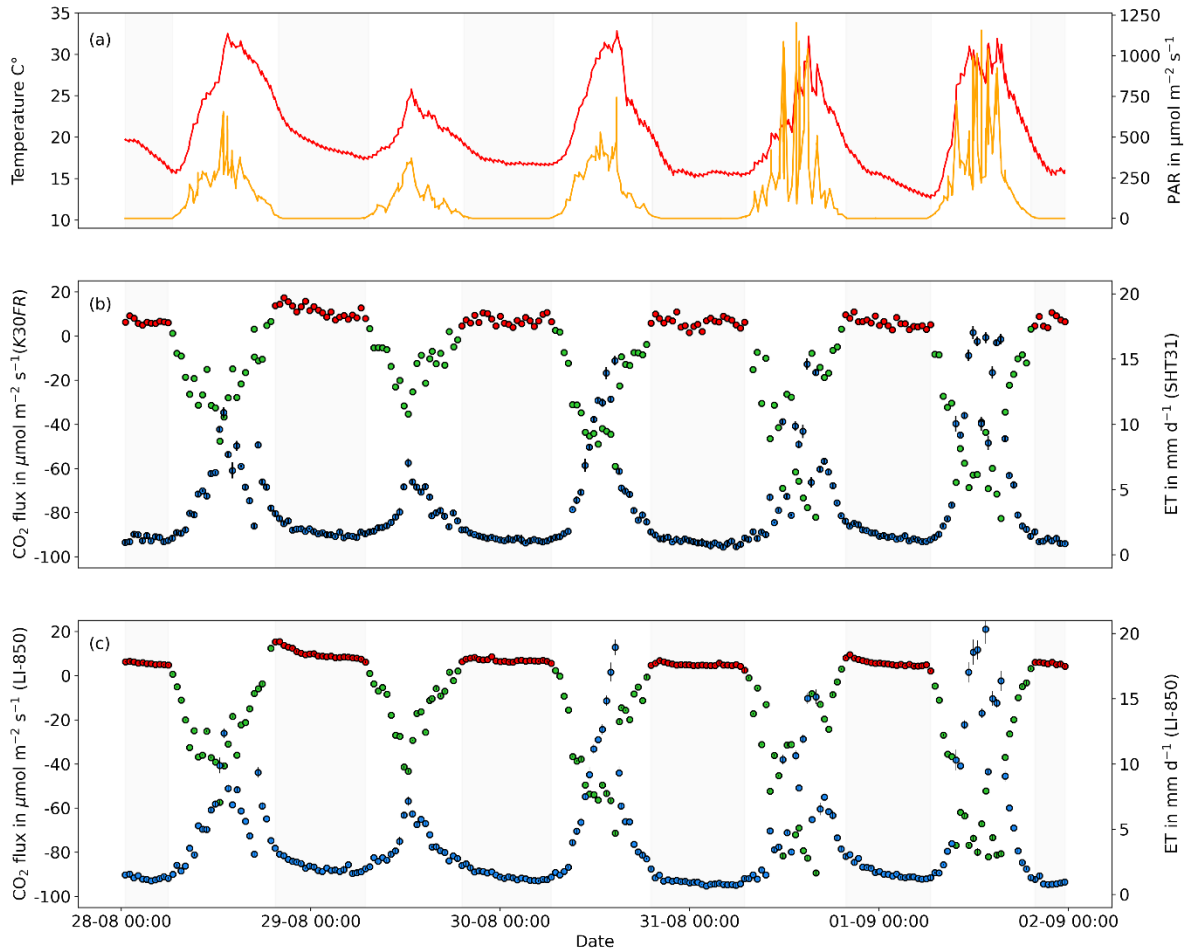

310

Figure 5 shows the 5-day trial conducted for the dependent mode. a) shows the air temperature (red line) and PAR (orange line), (b) show the diurnal cycle of CO₂ (R_{eco} : red points, NEE: green points) and ET fluxes (blue points) measured with low cost sensors (CO₂: K30 FR and ET: SHT31). (c) show the diurnal cycle of CO₂ (R_{eco} : red points, NEE: green points) and ET fluxes (blue points) measured with an infrared gas analyzer (LI-820, LI-COR Inc., Lincoln, USA). The gray shaded areas represent the nighttime. Error bars indicate calculated fluxes error.

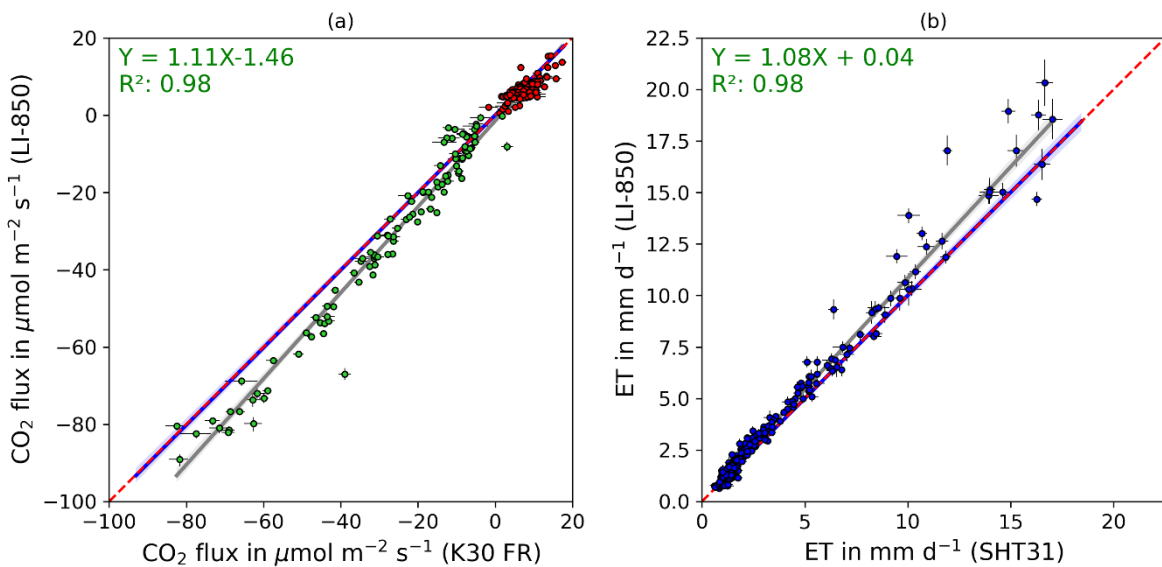

315

Figure 6: 1:1 agreement between (a) CO₂ fluxes (Reco: red points, NEE: green points) measured with an infrared gas analyzer (LI-850, LI-COR, USA) and low cost NDIR sensor (K30 FR). As well as (b) ET fluxes (blue points) measured with an infrared gas analyzer (LI-820, LI-COR Inc., Lincoln, USA) and low cost RH sensor (SH31). The dashed red

line indicates the 1:1 agreement. The grey line shows the linear regression of the measured CO₂ and ET fluxes, while the grey shaded area represents the respective confidence band of the regression line. The blue line shows the linear regression of the corrected measured CO₂ and ET fluxes, while the blue shaded area represents the respective confidence band of the regression line. Error bars indicate calculated flux error.

320 3.2.2. Dependent mode

The performed validation experiment, testing multiple Greenhouse Coffins with different treatments in dependent mode, proved that by connecting multiple Greenhouse Coffins via a low cost Multiplexer to a single infrared gas analyzer, CO₂ and ET fluxes can be fully automatized measured in a reliable and accurate manner. During the non-stop five days validation experiment for the dependent mode, the tested Greenhouse Coffins and the used low cost Multiplexer functioned reliably, with no system errors occurring. Thus, out of 237 conducted automatic measurements, more than 75 % and 99% passed the flux calculation algorithm for CO₂ and ET for the treatments with no plants (empty chamber), respectively. At the same time, 99% passed the flux calculation algorithm for CO₂ and ET for the other two treatments involving Sorghum and Maize, respectively. The limited number of valid CO₂ fluxes for the treatments with no plants can be attributed to the absence of significant changes in CO₂ fluxes during the measurement period. Consequently, many fluxes did not meet the IQR criteria set by the R module used for analysis. Moreover, the CO₂ fluxes showed no significant difference to zero (pairwise Wilcoxon signed-rank test, $p > 0.05$), which indicates the absence of cross-contamination due to the Multiplexer (Fig.7). The CO₂ and ET fluxes from the Greenhouse Coffins containing Sorghum and Maize exhibited distinct diurnal patterns. Both treatments showed low fluxes during nighttime and higher ET fluxes and CO₂ uptake during daytime, clearly followed monitored environmental parameters with higher ET fluxes and CO₂ uptake with higher PAR and a higher R_{eco} (nighttime measurements) with higher air temperatures (Fig. 7). Notably, Sorghum treatment showed higher ET fluxes and CO₂ uptake compared to Maize treatment. This disparity can be explained by variations in transpiration as well as physiological responses to environmental conditions between these two plants (Farré and Faci 2006). The results highlight the system's ability to detect the diurnal cycles of CO₂ and ET for different treatments. This feature is highly advantageous for Greenhouse studies as it allows researchers to focus on specific conditions or treatments while keeping the complexity of uncontrolled conditions, such as mesocosm experiments. (Zaman et al. 2021) and (Bréchet et al. 2021) demonstrated the benefits of high-frequency measurements for monitoring gas fluxes from different treatments; however, their studies were conducted under field conditions using commercial Multiplexers. Furthermore, the system's capacity to link multiple Greenhouse Coffins to one gas analyzer and carry out measurements automatically serves to cut down on the cost as well as time that would otherwise be spent in such experiments. Finally, the choice between stand alone, fully low cost based mode and Multiplexer connected cost efficient connected system allows for large degree of flexibility when planning experiments in terms of the target fluxes to analyzed (e.g. only CO₂ and H₂O compared to other trace gases or stable isotope analysis, where low cost sensors are not available).

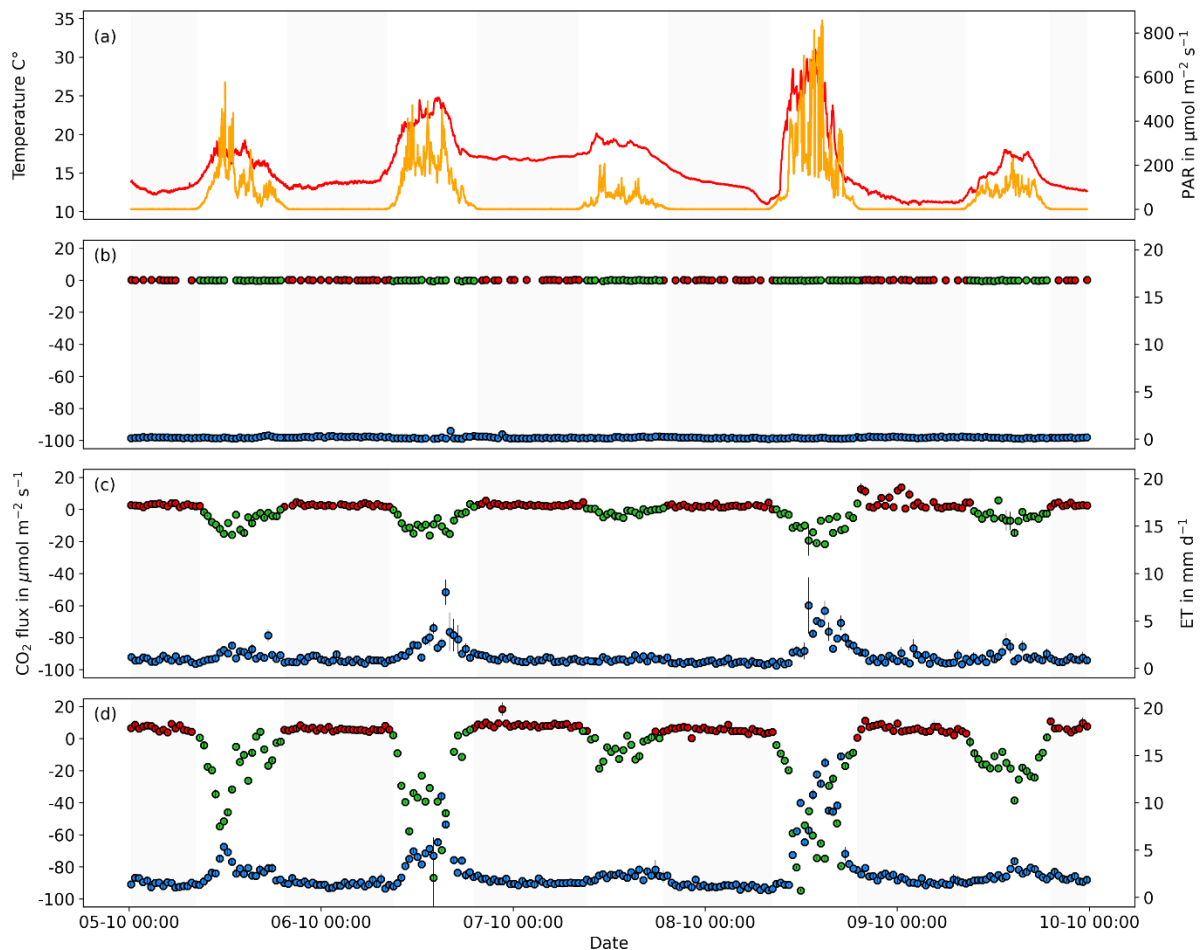

350 Figure 7 shows the 5-day trial conducted for the dependent mode. a) shows the air temperature (red line) and PAR (orange line), (b, c, and d) show the diurnal cycle of CO₂ (R_{eco} : red points, NEE: green points) and ET fluxes (blue points) measured with an infrared gas analyzer (LI-850, LI-COR, USA) for three different chambers (a: without plant, b: Maiz plant, d: sorghum plant). The gray shaded areas represent the nighttime. Error bars indicate calculated fluxes error.

355 4. Conclusions and implications for further use:

The presented novel, low cost, automatic soil-plant enclosure system allows for accurate and precise continuous monitoring of gaseous exchange fluxes during pot or mesocosm experiments. This was exemplarily shown during a Greenhouse pot experiment for CO₂ and ET fluxes of maize and sorghum. Performed system validation proved that, after calibration, CO₂ and ET fluxes can be determined accurately and precisely using low cost NDIR and RH sensors (independent mode). However, more importantly, by adding a low cost Multiplexer to the enclosure system, other GHGs can be measured as well through adding a gas analyzer and measuring the “Greenhouse Coffins” in row (dependent mode). Both modes allow for cost-effective, high-temporal-resolution measurements of soil-plant gas exchange across various treatments. In addition, the low cost modular character of the system allows for multiple further enhancements such as:

- 365 I. Parallel, high-resolution measurements of various gasses such as CO₂, CH₄, N₂O, and H₂O or also stable isotopes through combining high and low cost sensors, thus allowing to determine water use efficiency, net ecosystem carbon exchange, as well as full GHG balances. However, to ensure proper sealing, thorough sealing tests are crucial, particularly since gases like N₂O and CH₄ have low mixing ratios. Additionally, careful consideration must be given to the materials used in the construction, as they may emit e.g., volatile organic compounds that could affect the accuracy of their measurements.

- II. Integrating proximal sensing of crop health and development using available low cost measurement systems to detect spectral crop indices such as NDVI or RVI.

In summary, the developed and presented system can be a valuable tool for conducting Greenhouse experiments, particularly those with a high level of complexity (e.g., mesocosm experiment), allowing for holistically testing the dynamic responses of plants to various treatments and conditions while significantly reducing the required cost and labor

5. Code and data availability:

The data and code referred to in this study are publicly accessible at DOI: <https://doi.org/10.4228/ZALF-JG04-HV79>

6. Author contributions:

MH, WA and MD conceptualized and developed the system and codes. WA carried out the sealing and validation experiments. WA, MH, MD and JS wrote and prepared the manuscript with contributions from all co-authors. All authors have reviewed and agreed to the final version of the paper.

7. Competing interests:

The contact author has declared that none of the authors has any competing interests.

8. Acknowledgments

Special thanks go to Andrea Hoppe for her help in the Greenhouse during the system's construction.

9. Financial support

This research has been supported by the Leibniz Society Germany for their funding through the Leibniz Cooperative Excellence program (K378/2021) awarded to Joerg Schaller. The Open Access Fund of the Leibniz Association funded the publication of this article.

10. References

Ali, Akram Syed; Zanzinger, Zachary; Debose, Deion; Stephens, Brent: Open Source Building Science Sensors (OSBSS): A low-cost Arduino-based platform for long-term indoor environmental data collection. In 0360-1323 100, pp. 114–126. DOI: 10.1016/j.buildenv.2016.02.010 (2016).

Allen, R. G.; Pereira, L. S.; Raes, D.; Smith, M.: Crop evapotranspiration-Guidelines for computing crop water requirements-FAO Irrigation and drainage paper 56. Available online at https://www.scscourt.org/complexcivil/105cv049053/volume3/172618e_5xagwax8.pdf. ISBN 92-5-104219-5 (1998)

Altieri, Miguel A.; Nicholls, Clara I.; Henao, Alejandro; Lana, Marcos A.: Agroecology and the design of climate change-resilient farming systems. In *Agron. Sustain. Dev.* 35 (3), pp. 869–890. DOI: 10.1007/s13593-015-0285-2 (2015).

Bastviken, D., Sundgren, I., Natchimuthu, S., Reyier, H., & Gålfalk, M.. Cost-efficient approaches to measure carbon dioxide (CO₂) fluxes and concentrations in terrestrial and aquatic environments using mini loggers. *Biogeosciences*, 12(12), 3849-3859 DOI:10.5194/bg-12-3849-2015 (2015).

Blackstock, Joshua M.; Covington, Matthew D.; Perne, Matija; Myre, Joseph M.: Monitoring Atmospheric, Soil, and Dissolved CO₂ Using a Low-Cost, Arduino Monitoring Platform (CO₂-LAMP): Theory, Fabrication, and Operation. In *Front. Earth Sci.* 7, Article 313, p. 461703. DOI: 10.3389/feart.2019.00313 (2019).

Bonilla-Cordova, Mirko; Cruz-Villacorta, Lena; Echegaray-Cabrera, Ida; Ramos-Fernández, Lia; Del Flores Pino, Lisveth: Design of a Portable Analyzer to Determine the Net Exchange of CO₂ in Rice Field Ecosystems. In *Sensors* 24 (2), p. 402. DOI: 10.3390/s24020402 (2024).

- Bréchet, Laëtitia M.; Daniel, Warren; Stahl, Clément; Burban, Benoît; Goret, Jean-Yves; Salomón, Roberto L.; Janssens, Ivan A.: Simultaneous tree stem and soil greenhouse gas (CO₂, CH₄, N₂ O) flux measurements: a novel design for continuous monitoring towards improving flux estimates and temporal resolution. In *New Phytologist* 230 (6), pp. 2487–2500. DOI: 10.1111/nph.17352 (2021).
- 415 Cannon, J. B.; Warren, L. T.; Ohlson, G. C.; Hiers, J. K.; Shrestha, M.; Mitra, C. et al.: Applications of low-cost environmental monitoring systems for fine-scale abiotic measurements in forest ecology. In *Agricultural and Forest Meteorology* 321, p. 108973. DOI: 10.1016/j.agrformet.2022.108973 (2022).
- Chataut, Gopi; Bhatta, Bikram; Joshi, Dipesh; Subedi, Kabita; Kafle, Kishor: Greenhouse gases emission from agricultural soil: A review. In *2666-1543* 11, p. 100533. DOI: 10.1016/j.jafr.2023.100533 (2023).
- Dahlmann, Adrian; Hoffmann, Mathias; Verch, Gernot; Schmidt, Marten; Sommer, Michael; Augustin, Jürgen; Dubbert, Maren: Benefits of a robotic chamber system for determining evapotranspiration in an erosion-affected, heterogeneous cropland. In *Hydrol. Earth Syst. Sci.* 27 (21), pp. 3851–3873. DOI: 10.5194/hess-27-3851-2023 (2023).
- 425 D’Ausilio, Alessandro: Arduino: a low-cost multipurpose lab equipment. In *Behav Res* 44 (2), pp. 305–313. DOI: 10.3758/s13428-011-0163-z (2012).
- Farré, Imma; Faci, José María: Comparative response of maize (*Zea mays* L.) and sorghum (*Sorghum bicolor* L. Moench) to deficit irrigation in a Mediterranean environment. In *Agricultural Water Management* 83 (1-2), pp. 135–143. DOI: 10.1016/j.agwat.2005.11.001 (2006).
- 430 Fisher, Daniel K.; Gould, Peter J.: Open-Source Hardware Is a Low-Cost Alternative for Scientific Instrumentation and Research. In *MI* 01 (02), pp. 8–20. DOI: 10.4236/mi.2012.12002 (2012).
- Forbes, Elizabeth; Benenati, Vincent; Frey, Spencer; Hirsch, Mare; Koech, George; Lewin, Grace et al.: Fluxbots: A Method for Building, Deploying, Collecting and Analyzing Data From an Array of Inexpensive, Autonomous Soil Carbon Flux Chambers. In *JGR Biogeosciences* 128 (6), Article e2023JG007451, e2023JG007451. DOI: 10.1029/2023JG007451 (2023).
- 435 Hoffmann, Mathias; Jurisch, Nicole; Albiac Borraz, Elisa; Hagemann, Ulrike; Drösler, Matthias; Sommer, Michael; Augustin, Jürgen: Automated modeling of ecosystem CO₂ fluxes based on periodic closed chamber measurements: A standardized conceptual and practical approach. In *Agricultural and Forest Meteorology* 200, pp. 30–45. DOI: 10.1016/j.agrformet.2014.09.005 (2015).
- 440 Hoffmann, Mathias; Pehle, Natalia; Huth, Vytas; Jurisch, Nicole; Sommer, Michael; Augustin, Jürgen: A simple method to assess the impact of sealing, headspace mixing and pressure vent on airtightness of manually closed chambers. In *Journal of Plant Nutrition and Soil Science* 181 (1), pp. 36–40. DOI: 10.1002/jpln.201600299 (2018).
- 445 Hupp, J.: The importance of water vapor measurements and corrections. LI-COR Biosciences Inc. Application Note, 129, 8. (2011).
- Joshua B. Fisher; Forrest Melton; Elizabeth Middleton; Christopher Hain; Martha Anderson; Richard Allen et al.: The future of evapotranspiration: Global requirements for ecosystem functioning, carbon and climate feedbacks, agricultural management, and water resources. In *Water Resources Research* 53 (4), pp. 2618–2626. DOI: 10.1002/2016WR020175 (2017).
- 450 Lal, R.: Soil carbon sequestration to mitigate climate change. In *Geoderma* 123 (1-2), pp. 1–22. DOI: 10.1016/j.geoderma.2004.01.032 (2004).
- Macagga, Reena; Asante, Michael; Sossa, Geoffroy; Antonijević, Danica; Dubbert, Maren; Hoffmann, Mathias: Validation and field application of a low-cost device to measure CO₂ and evapotranspiration (ET) fluxes. In *Atmos. Meas. Tech.* 17 (4), pp. 1317–1332. DOI: 10.5194/amt-17-1317-2024 (2024).
- 455 Martin, Cory R.; Zeng, Ning; Karion, Anna; Dickerson, Russell R.; Ren, Xinrong; Turpie, Bari N.; Weber, Kristy J.: Evaluation and environmental correction of ambient CO₂ measurements from a low-cost NDIR sensor. In *Atmos. Meas. Tech.* 10 (7), pp. 2383–2395. DOI: 10.5194/amt-10-2383-2017 (2017).

NOAA, <https://www.noaa.gov/>, last access: 01 May 2024.

- 460 Olf, Hans-Werner; Westerschulte, Matthias; Ruoss, Nicolas; Federolf, Carl-Philipp; Zurheide, Tim; Vergara Hernandez, Maria Elena et al.: A new chamber design for measuring nitrous oxide emissions in maize crops. In *Journal of Plant Nutrition and Soil Science* 181 (1), pp. 69–77. DOI: 10.1002/jpln.201700008 (2018).
- Powlson, David S.; Stirling, Clare M.; Thierfelder, Christian; White, Rodger P.; Jat, M. L.: Does conservation agriculture deliver climate change mitigation through soil carbon sequestration in tropical agro-ecosystems? In *Agriculture, Ecosystems & Environment* 220, pp. 164–174. DOI: 10.1016/j.agee.2016.01.005 (2016).
- 465 Riebesell, U.; Czerny, J.; Bröckel, K. von; Boxhammer, T.; Büdenbender, J.; Deckelnick, M. et al.: Technical Note: A mobile sea-going mesocosm system – new opportunities for ocean change research. In *Biogeosciences* 10 (3), pp. 1835–1847. DOI: 10.5194/bg-10-1835-2013 (2013).
- Riederer, M.; Serafimovich, A.; Foken, T.: Net ecosystem CO₂ exchange measurements by the closed chamber method and the eddy covariance technique and their dependence on atmospheric conditions. In *Atmos. Meas. Tech.* 7 (4), pp. 1057–1064. DOI: 10.5194/amt-7-1057-2014 (2014).
- 470 Savage, Kathleen E.; Davidson, Eric A.: A comparison of manual and automated systems for soil CO₂ flux measurements: trade-offs between spatial and temporal resolution. In *J Exp Bot* 54 (384), pp. 891–899. DOI: 10.1093/jxb/erg121 (2003).
- Smith, Pete; Lanigan, Gary; Kutsch, Werner L.; Buchmann, Nina; Eugster, Werner; Aubinet, Marc et al.: Measurements necessary for assessing the net ecosystem carbon budget of croplands. In *Agriculture, Ecosystems & Environment* 139 (3), pp. 302–315. DOI: 10.1016/j.agee.2010.04.004 (2010).
- Stewart, Rebecca I.A.; Dossena, Matteo; Bohan, David A.; Jeppesen, Erik; Kordas, Rebecca L.; Ledger, Mark E. et al.: Mesocosm Experiments as a Tool for Ecological Climate-Change Research. In *Advances in Ecological Research* 48, pp. 71–181. DOI: 10.1016/B978-0-12-417199-2.00002-1 (2013).
- 480 Sun, X., & May, A. (2013). A comparison of field-based and lab-based experiments to evaluate user experience of personalised mobile devices. *Advances in Human-Computer Interaction*, 2013(1), 619767. DOI:10.1155/2013/619767
- Tubiello, Francesco N.; Salvatore, Mirella; Rossi, Simone; Ferrara, Alessandro; Fitton, Nuala; Smith, Pete: The FAOSTAT database of greenhouse gas emissions from agriculture. In *Environ. Res. Lett.* 8 (1), p. 15009. DOI: 10.1088/1748-9326/8/1/015009 (2013).
- 485 Ummenhofer, Caroline C.; Meehl, Gerald A.: Extreme weather and climate events with ecological relevance: a review. In *Philosophical transactions of the Royal Society of London. Series B, Biological sciences* 372 (1723). DOI: 10.1098/rstb.2016.0135 (2017).
- Webb, E. K.; Pearman, G. I.; Leuning, R.: Correction of flux measurements for density effects due to heat and water vapour transfer. In *Quart J Royal Meteor Soc* 106 (447), pp. 85–100. DOI: 10.1002/qj.49710644707 (1980).
- 490 Werle, P.: Accuracy and precision of laser spectrometers for trace gas sensing in the presence of optical fringes and atmospheric turbulence. In *Appl. Phys. B* 102 (2), pp. 313–329. DOI: 10.1007/s00340-010-4165-9 (2011).
- Zaman, M.; Kleinedam, K.; Bakken, L.; Berendt, J.; Bracken, C.; Butterbach-Bahl, K. et al.: Methodology for Measuring Greenhouse Gas Emissions from Agricultural Soils Using Non-isotopic Techniques. In : *Measuring Emission of Agricultural Greenhouse Gases and Developing Mitigation Options using Nuclear and Related Techniques*. Cham: Springer International Publishing, pp. 11–108. DOI: 10.1007/978-3-030-55396-8 (2021)
- 495 Zhang, Y.; Li, C.; Zhou, X.; Moore III, B.: A simulation model linking crop growth and soil biogeochemistry for sustainable agriculture. In *Ecological Modelling* 151 (1), pp. 75–108. DOI: 10.1016/S0304-3800(01)00527-0 (2002).
- 500