

Tesseract - A High-Stability, Low-Noise Fluxgate Sensor Designed for Constellation Applications

Kenton Greene¹, Christian Hansen¹, B. Barry Narod², Richard Dvorsky¹, David M. Miles¹

¹Department of Physics and Astronomy, University of Iowa, Iowa City, IA, USA

5 ²Department of Earth, Ocean and Atmospheric Sciences, University of British Columbia, Vancouver, Canada

Correspondence to: Kenton Greene (kenton-greene@uiowa.edu)

Abstract. Accurate high-precision magnetic field measurements are a significant challenge for many applications including constellation missions studying space plasmas. Instrument stability and orthogonality are essential to enable meaningful comparison between disparate satellites in a constellation without extensive cross-calibration efforts. Here we describe the design and characterization of Tesseract - a fluxgate magnetometer sensor designed for low-noise, high-stability constellation applications. Tesseract's design takes advantage of recent developments in the manufacturing of custom low noise fluxgate cores. Six of these custom racetrack fluxgate cores are securely and compactly mounted within a single solid three-axis symmetric base. Tesseract's feedback windings are configured as a four-square Merritt coil to create a large homogenous magnetic null inside the sensor where the fluxgate cores are held in near-zero field, regardless of the ambient magnetic field, to improve the reliability of the core magnetization cycle. A Biot-Savart simulation is used to optimize the homogeneity of field generated by the feedback Merritt Coils and was verified experimentally to be homogeneous within 0.42 percent along the racetrack cores' axes. The thermal stability of the sensor's feedback windings is measured using an insulated container filled with dry ice inside a coil system. The sensitivity over temperature of the feedback windings is found to be between 13 ppm/°C and 17 ppm/°C. The sensor's three axes maintain orthogonality to within at most 0.015 degrees over a temperature range of -45 °C to 20 °C. Tesseract's cores achieve a magnetic noise floor of 5 pT/√Hz at one Hz. Tesseract will be flight demonstrated on the ACES-II sounding rockets, currently scheduled to launch in late 2022 and again aboard the TRACERS satellite mission as part of the MAGIC technology demonstration which is currently scheduled to launch in 2023.

Deleted: ; an improvement thirteen times that of the traditional ring-core sensor design.

Deleted: ; an improvement at least six times that of the ring-core sensor design.

1 Introduction

Constellation satellite missions have an important role in the future of space plasma science. The NASA Heliophysics Science and Technology Roadmap for 2014–2033, states a driver of scientific discovery will come from a constellation mission of 30 or more spacecraft (Heliophysics Roadmap 2014). Recent missions such as Cluster (Balogh et al., 2001), Swarm (Merayo et al., 2008), Space Technology 5 (Slavin et al., 2008), Time History of Events and Macroscale Interactions during Substorms (Auster et al., 2008) and The Magnetospheric Multiscale Mission (Torbert et al., 2016) have successfully flown constellations of three to five spacecraft and have made significant contributions to the understanding of solar wind and magnetospheric physics (Ganushkina et al., 2017; Nakariakov et al., 2016 and the references therein). The environmental conditions experienced over the course of these magnetospheric constellation missions are representative for almost all space born magnetometers: they are subject to a wide range of magnetic field (low field at apogee, high field at perigee), radiation exposure, and temperature changes due to eclipse crossings. Recent developments in nanosatellite technology promise to provide a platform for the future of constellation missions at a low cost (Bandyopadhyay et al., 2015). Such a nanosatellite constellation mission could accurately resolve and characterize the spatial and temporal evolution of magnetic fluctuations that are indicative of larger scale magnetospheric processes, such as plasma waves,

Deleted: ¶

Deleted: are acknowledged

Deleted: recognizes that one of the opportunities to drive

Deleted: ST-

Deleted: THEMIS

45 field aligned currents and plasma transport at various scales. However, constructing a magnetic sensor with sufficiently small mass
and volume to be accommodated on a nanosatellite, while still maintaining the instrumental accuracy and precision required for a
magnetospheric constellation mission is not a trivial task. As the size of a fluxgate sensor is reduced, it becomes increasingly
difficult to preserve the stability required for reliable multi-point cross-comparisons. This presents a significant challenge for the
use of nanosatellites on constellation missions. The 2015 NASA Technology Roadmap has noted the importance of addressing the
50 challenge of “high measurement stability to allow inter-satellite calibration” to enable “high-stability magnetic field measurements
that can be made in distributed systems” (2015 NASA Technology Roadmap 8.3.1.3).

1.1 Fluxgate Sensor Stability

Fluxgate magnetometers do not measure the magnetic field absolutely and therefore must be calibrated in order to make accurate
measurements. However, the calibration parameters; sensitivity, orthogonality, and offset, vary with changes temperature or over
55 time. Fluxgate stability is the degree to which these calibration parameters remain constant. Fluxgate stability is critically important
for a magnetospheric constellation mission, as it enables comparison of disparate magnetic measurements without the need for
intensive cross calibration. However, it remains poorly understood and is not explicitly addressed by many authors in the literature.
Fluxgate offsets are thought to originate primarily from the cores and driving electronics (Ripka et al., 2014), while changes in
sensitivity and orthogonality are caused predominately by changes in the geometry of the sensor (Acuna et al., 1978; Miles et al.,
60 2017). In this paper, we are concerned with the stability of the sensor. Factors suspected of degrading a fluxgate sensor’s stability
include an inhomogeneous magnetic null (Ripka, 1992) and skewing of the axes due to mechanical and thermal strain (Primdahl,
1979).

Fluxgate magnetometers (Primdahl, 1979) measure the static and low-frequency vector magnetic field by modulating or gating the
local magnetic flux and measuring the induced electromagnetic force (EMF) in a sense winding. A ferromagnetic core, periodically
65 driven into magnetic saturation at frequency f , is used to gate the local field, thereby inducing a second harmonic ($2f$) signal due
to the nonlinear magnetic permeability of the core as it enters magnetic saturation twice per cycle. In this paper, we will be
discussing only second harmonic fluxgates. In many instruments, including that presented here, magnetic feedback is used to null
the magnetic field in the sensor, which linearizes and extends the measurement range of the instrument and is thought to improve
overall fluxgate stability (Primdahl and Jensen, 1982). Our magnetic sensors that are nulled in two axes, such as the CASSIOPE/e-
70 POP fluxgate which maintained a sensitivity stability of approximately of 18 ppm/°C (i.e., Wallis et al., 2015; Miles et al., 2013),
outperform our sensors zeroed in only a single component (i.e. Narod and Bennet, 1990; Acuña et al 1978) which achieved a
stability of 26 ppm/°C over the temperatures ranges from -20°C to 40°C. Thus, we hypothesize that a null in all three axes will
further improve stability compared to one or two axis nulled sensor designs.

1.2 Current State of High Stability Constellation Fluxgate Sensors

75 Recent constellation missions have increasingly focused on flying three axis compensated sensors in the interest of maximizing
instrumental stability. However, sensor designs that have flown on past constellation missions have been constrained to
accommodate a traditional one-inch diameter ring-core geometry ferromagnetic core.

Potentially the most stable magnetospheric field fluxgate measurements to date were taken with the Compact Spherical Coil (CSC)
Sensor aboard Swarm which implements a nested three axis feedback coil wound on a MACOR shell to create a very homogenous
80 a three-axis null at the location of the cores. From Primdahl and Jensen (1982), we estimate that the CSC’s feedback coils hold

Deleted: (
Deleted: ..
Deleted:)
Deleted: (
Deleted:)
Deleted: (
Deleted:)

their ring-cores in a field that deviates from uniformity by 1.5%. The 100×100×50 mm, 500 g CSC sensor has maintained a sensitivity stability over temperature of 10 ppm/°C and very high axis stability of 0.002 degrees from -20°C to 40°C while achieving a noise floor of 6.6 pT/√Hz at 1 Hz (Merayo et al., 2008).

Deleted: instrument.

The THEMIS mission incorporated 70×70×45 mm, 75 g, low-mass fluxgate sensors that achieved a sensitivity stability of 22 ppm/°C, an axes' stability within 0.017 degrees from -100°C to 60°C and a noise of 10 pT/Hz at 1 Hz (Auster et al., 2008). The 42.4×44.3×48.7 mm, 88 g Magnetospheric Multiscale Mission DFG instrument achieved a sensitivity stability over temperature of 30 ppm/°C, an axis stability of about 0.03 degrees between -50°C and 30°C a noise floor of 8pT/√Hz at 1 Hz, (Russell et al.,

Deleted: From Primdahl and Jenson (1982), we estimate that the CSC's feedback coils hold their ring-cores in a field that deviates from uniformity by 1.5%.

Deleted: 42.4×44.3×48.7 mm

2016). Notably, the temperature dependent sensitivity can be corrected to first order by fluxgate electronics using compensated feedback current (Primdahl 1970; Acuña et al., 1978; Miles et al., 2017); however, no equivalent compensation exists for orthogonality. In general, smaller temperature dependent sensitivity is desirable but smaller orthogonality dependence is more critical.

Deleted: an axis stability of about 0.03 degrees between -50°C and 30°C, and a sensitivity stability over temperature of 30 ppm/°C after compensation was applied

Future constellation missions, such as Geospace Dynamics Constellation (Pfaff et al., 2016), MagneToRE (Maruca et al., 2021) and NanoSWARM (Gerrick-Bethell et al., 2021) promise to build on the success of these constellation magnetometers, and the continued development of increasingly precise, robust, magnetic field instruments remains an important means to these efforts.

1.3 Current State of Miniaturized Fluxgate Sensors

Nanosatellites as a platform for magnetospheric measurements are an emerging topic in the literature. Some tend to focus on miniaturizing traditional fluxgate magnetometer designs for CubeSat applications without overly compromising their measurement capability (e.g., Ripka, 2003 and references therein). Recent missions, such as Dellingr and ExAlta1, have implemented miniaturized, boom-deployed fluxgate magnetometers on nanosatellites. The Dellingr nanosatellite flew a very small 19g fluxgate magnetometer with a noise floor of 120 pT/√Hz at 1 Hz (Kepko et al., 2017). The Ex-Alt1 CubeSat flew a 47g miniaturized fluxgate sensor with a noise floor of 150 pT/√Hz at 1 Hz (Miles et al., 2016). However, these miniature instruments typically sacrifice noise and stability in the interest of small size. With a sensitivity stability poorer than 50 ppm/°C, these sensors function primarily as variometers. If used in a constellation setting, measurements from disparate sensors would be far less comparable than those from previous constellation mission without complex and time-consuming cross calibration. One of the best small sensors to date appears to be the Small Magnetometer in Low-mass Experiment (SMILE): a 20×20×20 mm, 40 g cubic sensor based on three rod cores within a three-axis feedback winding, which achieved a thermal sensitivity stability of 11 ppm/°C, an axis stability better than 0.02 degrees from -30 to 45°C, and 30 pT/√Hz at 1Hz (Forslund et al., 2008).

Deleted: developed by Forslund et al (2008),

Deleted: with

Deleted: a 40g, 20×20×20 mm cubic sensor based on three rod cores within a three-axis feedback winding

1.4 Tesseract Sensor Overview

Like the CSC and SMILE sensors, Tesseract's feedback windings create a three-axis 'magnetic null' inside the sensor where the fluxgate cores are held in near-zero field. This ensures that the cores do not exceed their linear sensitivity region regardless of the magnitude of the ambient magnetic field (Primdahl and Jensen, 1982). An inhomogeneous magnetic null at the cores is thought to contribute to degrading the stability of a fluxgate's offset (Ripka, 1992) sensitivity (Korepanov and Marusenkov 2012) and orthogonality (Petrucha et al 2015).

Deleted: known

Deleted: be a primary

Deleted: or

Deleted: stability

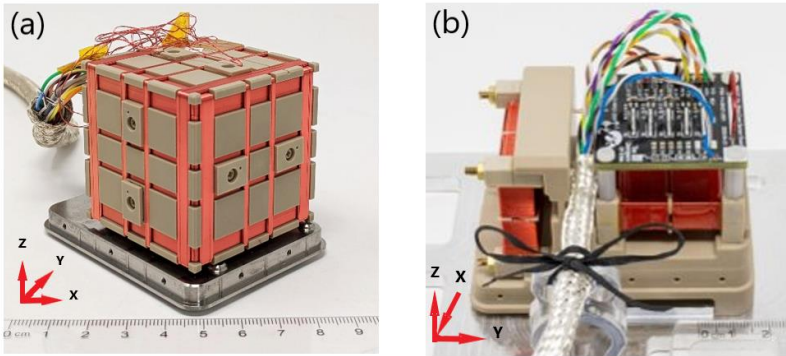

Figure 1: (a) A high fidelity prototype of the Tesseract sensor has been constructed for testing in preparation for MAGIC: a technology demonstration on the TRACERS satellite mission Tesseract's feedback coils are arranged in a three axis four-loop Merritt coil which is expected to create a large homogenous null region in the sensor. Tesseract's feedback coils are wound on a common base of 30% glass filled Torlon. (b) A two-axis null ring-core sensor design based on (Miles et al., 2013) was used in the testing described section 3 and is shown for comparison.

Here, we present the design and characterization of Tesseract: a high-stability fluxgate magnetometer for constellation missions. The Tesseract sensor's three-axis feedback windings are arranged in a four-square Merritt coil, which creates a proportionally larger homogeneous region than the Helmholtz coil for the same external volume (Merritt, 1983) allowing it to accommodate more cores (six instead of three). The idea of more complex feedback winding is not new. Designs such as Primdahl and Jensen (1982), Auster (2008) and Chulliat (2009) have used different methods of stacking concentric circular coils to create a three-axis null sensor. A study by Petrucha (2015) experimented with a laboratory prototype sensor that used a Merritt coil feedback topology with ring geometry cores. Tesseract's design draws inspiration from the aforementioned SMILE sensor (Forslund et al., 2008), which used three equally spaced square feedback coils and a parallel rod sensor in each axis to create a cube-shaped, three-axis nulled sensor. Tesseract's Merritt coil feedback winding has been optimized to hold six racetrack cores within a highly homogeneous null field (deviations from average of less than 0.42%), which allows for a reproducible magnetization of the ferromagnetic cores. This reproducibility is designed to improve the measurement stability (Ripka 1994; Korepanov and Marusenkov 2012) and linearity (Brauer et al., 1997) of the sensor.

Parameters	Tesseract Sensor	Ring-core Sensor <small>Miles et al., 2013</small>
Sensor Dimensions	50 x 50 x 50 mm	22 x 28 x 30 mm
Sensor Mass	340g	287g
Feedback Power Consumption at 65000 nT Earth Field	29.7 mW	14.4 mW
Noise Floor of Cores	5 pT/ $\sqrt{\text{Hz}}$ at 1 Hz	7 pT/ $\sqrt{\text{Hz}}$ at 1 Hz
Uncompensated Stability over Temperature*	13 - 17 ppm/ $^{\circ}\text{C}$	11 - 26 ppm/ $^{\circ}\text{C}$
Axis Orthogonality Angles Stability over Temperature*	< 0.015 Degrees	0.09 Degrees
Feedback Field Homogeneity at Cores	< 0.42%	< 5.62%

* In the range from -45 $^{\circ}\text{C}$ to 20 $^{\circ}\text{C}$

Table 1: The Tesseract Sensor's specifications as measured in the laboratory compared with the specifications of a more traditional ring-core sensor design described in Miles (2013). Tesseract is marginally larger than the Miles (2013) ring-core sensor design but has much higher axis stability and magnetic feedback homogeneity, which are associated with higher instrumental stability. The uncompensated Stability and Orthogonality angles are both measured from -45 $^{\circ}\text{C}$ to 20 $^{\circ}\text{C}$

Deleted: The
Deleted: traditional
Deleted: one-inch diameter
Deleted: based on that developed
Deleted: in this paper

Parameters
Sensor Dimensions
Sensor Mass
Feedback Power Consumption at 65000 nT Earth Field
Noise Floor of Cores
Uncompensated Stability over Temperature*
Axis Orthogonality Angles Stability over Temperature*
Feedback Field Homogeneity at Cores

Deleted: * In the range from -45 $^{\circ}\text{C}$ to 20 $^{\circ}\text{C}$

Tesseract's custom low noise racetrack geometry cores are securely and compactly mounted within a single solid three-axis symmetric base of 30% glass-filled Torlon, reducing the potential for mechanical strains due to uneven coefficients of linear expansion and reducing the tendency of the sensor to skew with temperature, thus limiting these potential sources of instrument instability. Tesseract's cores achieve a magnetic noise floor of $5 \text{ pT}/\sqrt{\text{Hz}}$ at one Hz, an orthogonality within 0.015 degrees and temperature stability of 13-17 ppm/°C between -45°C and 20°C.

2 Sensor Design

Tesseract is designed to mitigate known sources of instability such as uncompensated residual field inside the sensor and skewing of the axes and the cores due to mechanical and thermal stresses while still maintaining low noise and a small size. Here we describe the design, optimization, manufacturing, and assembly processes for the Tesseract sensor.

2.1 Racetrack Core Design

The noise floor of a fluxgate is typically limited by the intrinsic magnetic noise of a permalloy core that is periodically driven into magnetic saturation to modulate the local magnetic field. Recent development in custom low noise core manufacturing by Miles (2019) enabled us to create custom low-noise miniature racetrack sensors (Miles et al., 2022).

Custom permalloy created using the Miles et al., 2022 process is cold rolled into $50 \text{ }\mu\text{m}$ thick foil. The permalloy foil is then cut to 5 cm length, stacked, drilled, and secured in a tight bundle. A milling machine was used to machine 6.45 mm wide by 31.45 mm long racetrack foil washers. The racetrack washers are placed in the furnace, heat-treated, and stacked into a Torlon bobbin (Figure 2a) and interleaved with insulating layers of Kapton of the same geometry.

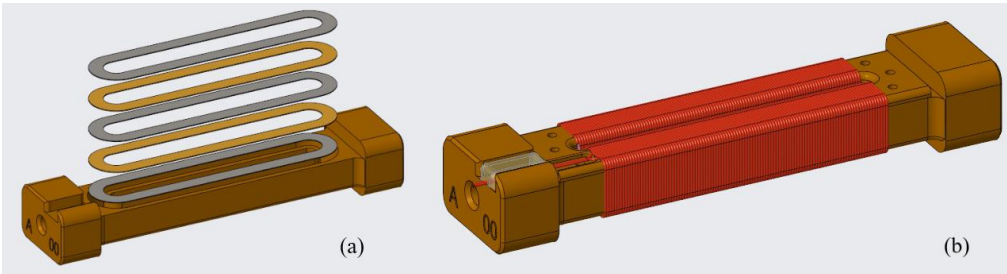

Figure 2: (a) Layers of foil loops are stacked within a Torlon bobbin with layer of Kapton placed in between permalloy layers. (b) The bobbin serves as a frame for the drive coils which are wound on the two long racetrack supports.

Production cores are interleaved with a polymer between the foil layers to prevent them from moving during the magnetizing drive pulses. A plastic lid closes the core and serves as a base upon which to wind a quasi-toroidal drive of AWG 32 magnet wire (Figure 2b). Finally, a solenoidal sense winding of AWG 34 magnet wire is wrapped around the length of the base.

The stacked foil washers remove the need to spot-weld, as is done in traditional spiral-wound sensors, avoiding the heat-affected area around the weld and its unpredictable magnetic properties. Heat-treating the foil washers individually removes the risk of undesired welding between layers that can cause unintended shorting. The race-track geometry aligns ferromagnetic mass on one axis, producing lower noise. However, the race-track geometry cannot be double-wound like a ring-core to sample two orthogonal components. The closed flux path of the racetrack should reduce stray fields and offset error compared to traditional parallel rod sensors (e.g., Janosek 2017; Moldovanu et al., 2000).

Deleted: A plastic lid closes the core and serves as a base upon which to wind a quasi-toroidal drive of AWG 32 magnet wire (Figure 2b). ...

Deleted: ¶

2.2 Sensor Base Design

Tesseract leverages this racetrack geometry to create a compact sensor. Six of these custom racetrack geometry cores are fixed within a three-axis symmetric 30% glass filled Polyamide-Imide (Torlon 5030) base in a compact configuration of two cores per axis shown in Figure 3a. ~~We hypothesize that~~ pairing of identical cores with opposite polarities in each axis ~~may further~~ reduce the tendency for cross-axis contamination ~~due to mutual cancellation of their stray fields (Ripka and Billingsley 2000)~~.

These cores are then secured firmly in place using polymeric and nonmagnetic screws so that they do not shift during vibration, but without exerting any mechanical stress on the core (Figure 3b). Vacuum tolerant epoxy is used to secure the drive windings to the cylindrical walls of the bobbin, thereby locking the drive winding in place without creating a rigid bond to the racetrack core.

The foil bobbin and the sensor base are manufactured from the same glass filled Torlon which will reduce the impact of mismatched coefficients of linear thermal expansions compared to sensors using the traditional Inconel bobbin. This further reduces the potential for mechanical stress.

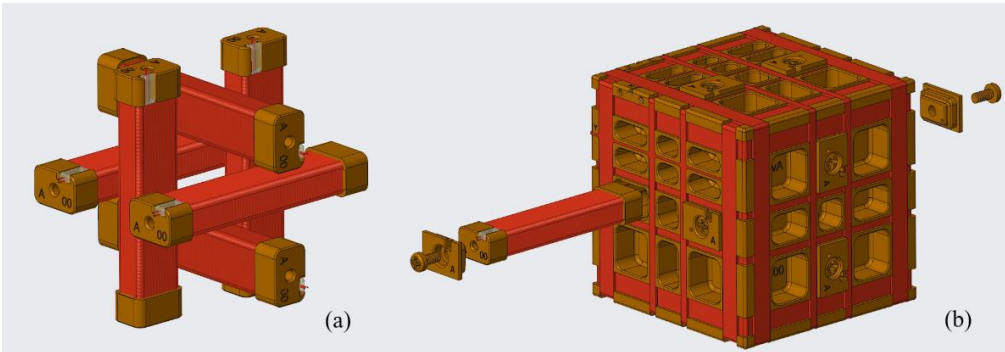

Figure 3: (a) Tesseract's six miniature racetrack cores are wound with a solenoidal sense winding, arranged in pairs/two per axis and (b) secured within one common Torlon base. The Tesseract sensor's Merritt coil feedback windings are wound in small, machined channels in this base.

Torlon is lighter and much easier to machine than the traditional Inconel ringcore bobbin used in Miles et al., 2013. Small channels of a predetermined width and depth are precisely and symmetrically machined into a Torlon block. This block serves as a common base upon which to wind Tesseract's three orthogonal feedback coils (3b in red). This single solid 3 axis symmetric base for all three sense coil axes is expected to further reduce the tendency of the sensor's axes to skew with temperature, thus preserving the orthogonality.

Additionally, a common base for the feedback windings provides a small, linear temperature dependence that can be characterized and then compensated in electronics. Fluxgate sensor measurements have long been known to vary with temperature (e.g., Trigg et al., 1971). Miles (2017) documents the historical technique (Acuña, 1978) of providing realtime analog temperature compensation. Temperature compensation can be provided electronically in real time by modifying the feedback current. A transconductance amplifier can be modified such that the normally constant voltage-to-current transfer function is engineered to respond to the load resistance provided by RTDs which are mounted in series with the feedback. This scaling of this transfer function allows, to first order, the effect of temperature on the load resistance offered by the sense winding to compensate for the effect of temperature on the sensor geometry.

The compensation is limited to the linear scaling of this transfer function, so it requires that the sensor be highly mechanically stable with temperature such that its thermal sensitivity dependence is functionally linear through the operating temperature range. 30% glass filled Torlon has a very linear response to temperature and with a thermal expansion coefficient of 16.2 ppm/°C, making

Deleted: This

Deleted: is expected to further

Deleted: due to stray fields

it an excellent base material for linear sensitivity temperature compensation. There are materials with a lower coefficient of thermal expansion, Torlon was selected to match the thermal expansion coefficient of the copper windings (16.7 ppm/°C) and minimize stress in the sensor. Tesseract takes advantage of this property of Torlon for effective real time linear temperature compensation, which should contribute to good measurement stability over changes in temperature. Torlon is also extremely resistant to shearing and skewing with temperature. We expect that this will reduce the tendency of the sensor's axes to skew with temperature.

2.3 Feedback Winding Design

Tesseract's three orthogonal feedback coils are wound into channels that have been machined symmetrically into the Torlon base (Figure 3b). A CNC winding machine is used to guide 40 AWG magnet wire into the channels so that there is no asymmetry or overlap. These feedback windings create a three-axis 'magnetic null' inside the sensor where the racetrack fluxgate cores are held in near-zero field. This ensures that the cores do not become oversaturated and exceed their linear sensitivity region regardless of the magnitude of the ambient magnetic field (Primdahl and Jensen, 1982). Retaining the cores in a homogeneous region, where the magnetic field can be effectively nulled, helps to ensure a reproducible magnetization of the ferromagnetic cores. This is thought to improve the sensor's measurement stability and linearity.

A homogeneous magnetic null at the cores improves stability over temperature by reducing the dependance of the sensitivity on the temperature dependance of the excitation current (Korepanov and Marusenkov 2012). A study by Petrucha et al (2015) determined that in a three-axis null sensor, changing the inhomogeneity of the magnetic feedback by that deviates from average along the core by 1.3%, can alter the measured alignment of the sensor's axes by as much as +/- 0.12 degrees. Brauer et al (1997) demonstrated that inhomogeneities as little as 1% causes 25 nT deviations from linearity when an uncompensated earth field is applied in a transverse axis. Tesseract's feedback windings are arranged as a four-square Merritt Coil in three axes. This configuration creates a relatively large homogeneous region relative to the coil's volume compared to a traditional Helmholtz Coil (Merritt, 1983).

Deleted: (Ripka1992)

2.3.1 Feedback Field Simulation

To analyze and optimize the design of the Tesseract sensor's feedback windings, we developed a Biot-Savart simulation of the magnetic field generated by these windings when a DC current is applied. The simulation of the magnetic field generated by the Tesseract's x-axis feedback coils, rendered in Figure 4a, is as a slice at the plane $z=0$ (Figure 4b). The main region of interest is the area occupied by racetrack cores (outlined in maroon), which is at $z=0$ mm, $y = \pm 12$ mm, and $x = \pm 15.7$ mm. For the purposes of this paper, the figure of merit for a feedback winding configuration will be the degree to which this winding holds the racetrack core axis in a homogeneous field; more explicitly, the maximum percentage that the magnetic field values along the $y = 12$ mm axis deviates from the average field along this axis.

Deleted: 15

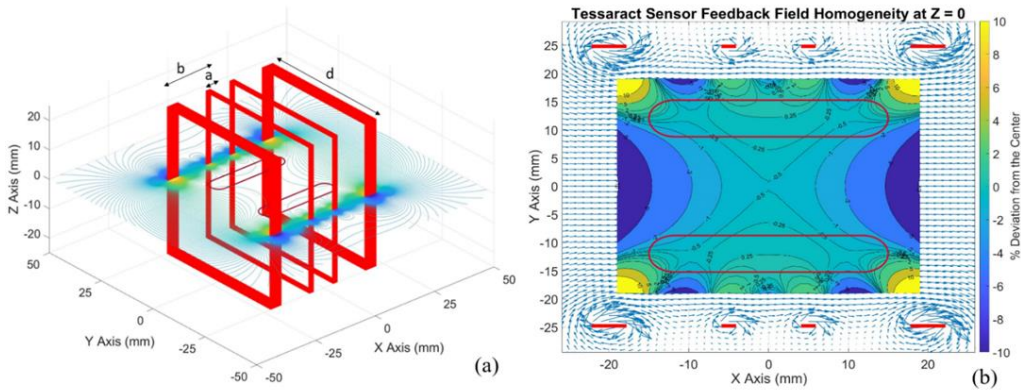

270 Figure 4: (a) A four square Merritt coil system is the basis of the design for the Tesseract sensor's feedback windings. A Biot-Savart
 simulation of the Tesseract's feedback winding models each loop of wire as a square array are assigned a position on a 3D grid. [Here we](#)
 show a render of the x axis feedback coil. (b) A two-dimensional cross section at $z = 0$ of the Biot-Savart model of the Tesseract sensor.
 275 The maroon loops outline the regions where the racetrack sensors are situated. The contours plot the percentage of deviation of the field
 from its average along the axis of the racetrack cores ($y = +12$ mm, -12 mm). In this region, maximum deviation of the magnetic field
 from the average field along the racetrack core is about 0.42%. Blue arrows map out the direction and magnitude of the B field, while
 the red dots represent the positions of the wires.

The simulation of the Tesseract sensor's feedback design suggests that the deviation from a uniform magnetic field along the 1D
 axis of the racetrack core (at $y = +12$ mm) does not exceed 0.45% (Figure 4b). We surmise that keeping Tesseract's racetrack cores
 immersed in this highly magnetically homogeneous region will contribute more stable, linear fluxgate performance.

280 In this simulation, each loop of wire in the Merritt Coil is modeled as a square array with an assigned length, current and a location
 on a 3D grid (Figure 4a). A Biot-Savart integration is applied over each element in the square array to evaluate the magnetic field
 at every point on this grid. This process is repeated for every loop in the coil system, and the resulting field values are summed
 to create a model of the total magnetic field generated by a Merritt coil system.

2.3.2 Feedback Winding Optimization

285 Merritt (1983) provides a natural starting place for constraining the possible positions of the wires. The classic four-square Merritt
 coil design, rendered in Figure 4a, groups wires into four 'channels', two outer channels and two inner channels, and places
 constraints on the size and position of each channel. The distance of the outer channel b and inner channel a from the center (labeled
 at the top of Figure 4a) must be related to the length of the coil d , such that $a/d = 0.1281$ and $b/d = 0.5055$. Additionally, the ideal
 Merritt coil geometry places constraints on the number of wire turns in each channel. For example, the number of wire turns
 290 on the inner channel must be 0.4235 times the number of turns on the outer channel (Merritt et al., 1983).

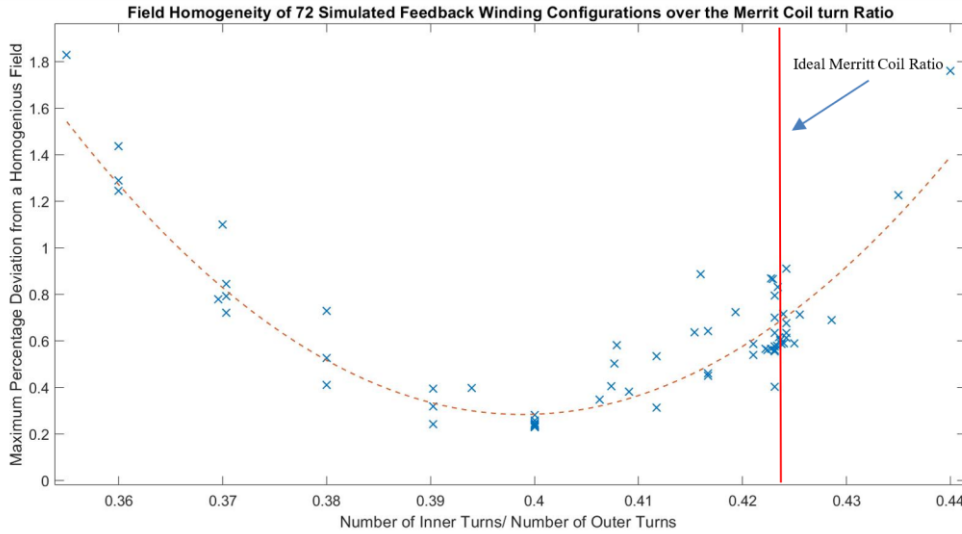

Figure 5: The percentage that the field along the racetrack core axis (at $y = 12$ mm, between $x = 15.7$ mm and -15.7 mm) deviates from average plotted against the ratio of inner loops of wire to outer loops. Seventy-two feedback winding configurations were simulated using the Biot-Savart model. The results of the simulation showed a relationship between the ratio of inner turns to outer turns with the homogeneity of the magnetic field. A quadratic fit with an R squared value of 0.8 suggests that an inner to outer turn ratio of 0.3985 is optimal for homogeneity.

However, given the physical constraints of manufacturing a three-axis sensor, it is necessary to violate these ratios slightly. The requirement for channel spacing must be broken such that $b/d < 0.5$ in order to maintain three-axis symmetry and the mechanical integrity of the Torlon. Other considerations about the winding (i.e. that the number of layers must be even to ensure that the terminating leads start and end in the same place so they can be terminated in a twisted pair) places further restrictions in the model. When all these constraints are applied, we are left with the wire gauge, number of wire turns, and the ratio of the number of inner loops to outer loops as parameters that can vary. The Biot-Savart model (Figure 4b) was used to simulate 72 possible feedback winding configurations and the results were analyzed to determine which feedback winding characteristics were optimal for generating a homogenous field along the axis of the racetrack cores.

The field homogeneity generated by a feedback winding was found to have a dependence on that winding's ratio of inner loops to outer loops. Figure 5 plots the percentage that the field at the racetrack core deviates from uniformity against the ratio of inner loops of wire to outer loops. A quadratic fit suggests that an inner to outer loop ratio of 0.3985 is optimal for homogeneity. This differs from the classic Merritt coil ratio of 0.4236. Shifting the inner to outer loop ratio compensates the earlier violation of the channel distance requirements for b/d defined in section 2.3.1 that were necessary to construct a physical sensor. Other parameters (wire gauge and total number of wire loops of the feedback winding) were not found to have a discernable correlation with the homogeneity of the feedback magnetic field.

In addition to feedback field homogeneity, another important consideration in selecting an optimal feedback configuration for a magnetospheric sensor is the power dissipation required for these feedback windings to null maximum earth field ~ 65000 nT. This power consumption per axis was calculated using the equation from Magdaleno-Adame, (2010):

$$P_{max} = I_{max} V = \frac{B_{max} d}{1.795 \times 10^{-6} * N} V \quad (1)$$

Where N is the total number of turns of wire, d is the length of one side of the square coil (as demarcated in figure 4), and for our purposes: $V = 5$ volts (the maximum voltage allowed by the operational amplifier) and $B = 65000$ nT (the maximum field experienced in orbit). This equation implies an inverse relationship between feedback power consumption at earth field P_{max} and the total number of loops of wire N . Thus, a feedback configuration with more loops of wire will require less power to null earth field with an upper limit of on the resistance of the coil of $\frac{V}{I_{max}}$ to ensure it can null the full field.

Of these 72 simulated feedback winding configurations, three were determined to be excellent candidates for good feedback homogeneity and power efficiency. Figure 6 shows the parameters of these configurations along with the modeled magnetic flux density distribution along the axis of the racetrack core for each of these optimized feedback configurations. Prototype #1 was the lowest power consumption configuration; Prototype #2 was the lowest inhomogeneity and Prototype #3 was chosen for a balance of low inhomogeneity and low power consumption.

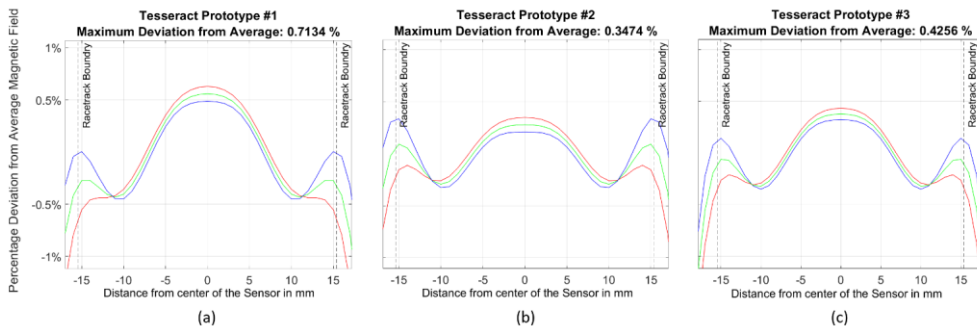

Figure 6: Homogeneity of the feedback magnetic field along the axis of the racetrack core for each axis of three optimized sensors. The racetrack core occupies the region between the vertical dashed black lines at -15.7 mm and 15.7 mm. Configuration (b) was optimized for best homogeneity while sensor (c) was chosen for good homogeneity with very low power consumption.

The configuration in Figure 6c with 864 turns and a wire gauge of 40 AWG was determined to be a suitable balance of good homogeneity and feedback power efficiency. The magnetic field along the racetrack core axis varies by less than 0.46% in the x axis, 0.38% in the y axis and 0.32% on the z axis. This design requires a sensor power consumption of 89.1 mW to compensate for a worst-case Earth field of 65000 nT, which is very reasonable for accommodation on a small satellite. This is the feedback winding design that we plan to implement on the flight-ready Tesseract magnetometer that will be flown on the ACES-II sounding rockets and again on the TRACERS satellites mission.

3 Sensor Characterization

The Tesseract sensor design was prototyped and subjected to a series of tests in order to evaluate the validity of our design models and to quantitatively characterize the sensor's performance. First, several prototype sensors were manufactured and tested for feedback winding homogeneity and stability over temperature. From the results of these initial tests, as described in this section, we selected the prototype that exhibited the most homogeneous feedback field.

Then, a high-fidelity prototype was manufactured with the specifications shown in Table 1. A series of tests were conducted on this prototype to quantify the characteristics of the Tesseract sensor: the feedback field uniformity, the sensitivity and orthogonality over changes in temperature, and the noise floor of the core. All the tests described in this section were conducted at the University of Iowa Magnetometer Calibration Facility.

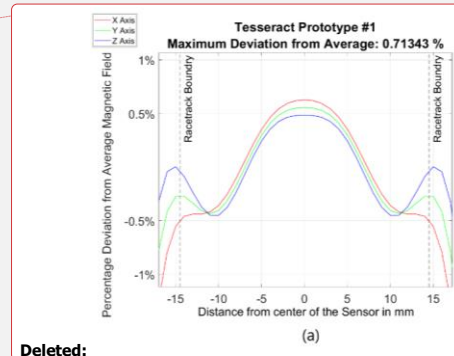

Deleted:

3.1 Feedback Field Homogeneity

In order to experimentally characterize the magnetic field generated by the feedback windings and test the results of the Biot-Savart model, three prototype sensors were manufactured with the optimized feedback winding configurations modeled in Figure 6. For our purposes, we are most interested quantifying the homogeneity of the feedback magnetic field along the axis of the racetrack core. Each prototype sensor was placed within a single axis solenoid within a three-layer mumetal magnetic shield and constant current of 20 mA was applied to the feedback windings creating a magnetic field of about 190,000 nT. A DC hall effect milligauss meter probe was placed in the center of the racetrack core's rectangular bore hole in the prototype bobbin and measurements of the magnetic field generated by this current were taken along the bore axis at 2.5 mm intervals. The final value for each measurement was found as an average of that value over four separate tests. The uncertainty was determined by the range over which each measured magnetic field value varied over the four tests. Figure 7 plots the measured magnetic flux distribution along the longest axis of the racetrack core for each prototype sensor as a percentage deviation from the average field value along the bore hole axis between -15.7 mm and 15.7 mm (the domain of the racetrack core).

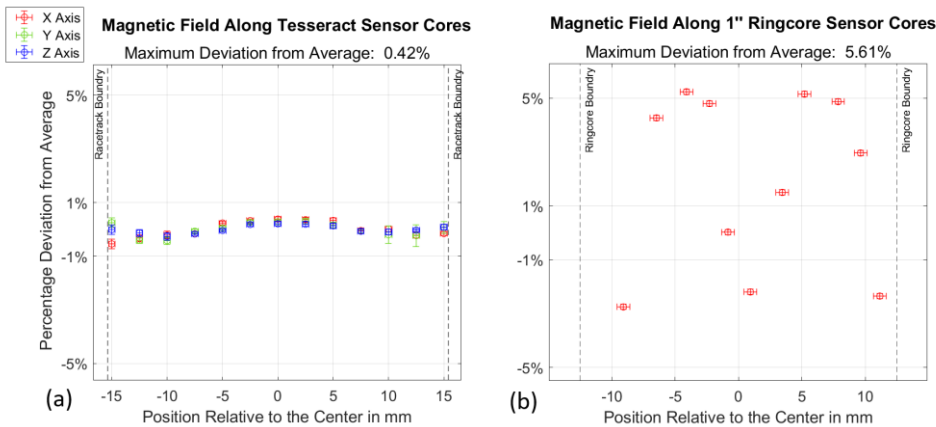

Figure 7: (a) The magnetic field generated by the Tesseract prototype #3 sensors' feedback windings was measured in 2.5 mm intervals along the axis of the racetrack bore hole. The magnetic field is plotted as the percentage deviation from the average value in the racetrack core region (between -15.7 mm and 15.7 mm). The feedback magnetic field does not deviate by more than 0.42% along the core axis and the feedback coils consume 29.7 mW to null earth field. (b) The measured percentage deviation of the magnetic field for each position along the axis of the ring-core hole. The magnetic field deviates as much as 5.62% in the domain of the one-inch ring-core (between -12.7 mm and 12.7 mm).

3.1.1 Comparison with Miles (2013) Ring-core Sensor Feedback Field

We performed the same test again, this time using our prototype feedback winding for the Miles (2013) 1" ring-core sensor (Figure 1b) which has similar geometry to its e-POP design (Wallis et al., 2015) and historical missions (e.g. Acuña, 1980). This ring-core sensor uses solenoidal windings which have similar dimensions for all three axes, so we expect the feedback field to be roughly the same for each axis. Figure 9 plots the measured magnetic flux distribution along the radial axis of the ring-core as a percentage deviation from the average field value in this region. Distance is measured from the center of the ring-core and the ring-core itself extends from 12.7 mm to -12.7 mm.

The maximum that the measured feedback field deviates from uniformity along the x axis of the Miles (2013) ring-core sensor is 5.62%. The Miles (2013) sensor's feedback windings generate a field the along the center axis of the ring-core that is ten times more inhomogeneous than that generated by the Tesseract sensor.

Formatted: Line spacing: 1.5 lines

Inset plot (a) titled 'Magnetic Field Along Tesseract S' shows a similar trend to plot (a) in Figure 7, with data points for X, Y, and Z axes clustered around 0% deviation. The maximum deviation from average is noted as 0.42%. The x-axis is 'Position Relative to the Center' and the y-axis is 'Percentage Deviation from Average'.

Deleted:
 Deleted: Ring-core
 Deleted: our
 Deleted: many
 Deleted: e
 Deleted: ring-core

3.1.2 Comparison with Biot-Savart Model

The feedback configuration of Prototype 3 (Figure 7c), with 864 turns of 40 AWG wire on each axis, was chosen to be the current high-fidelity sensor (Figure 1a) and will be flown on future missions. This feedback winding generates a magnetic field along the axis of its cores that deviates from average by a maximum of 0.42% in the x axis, 0.39% in the y axis and 0.26% in the z axis. To assess the effectiveness of our Biot-Savart simulation experimentally, we directly compared these data to the model output for the field values along the axis of the racetrack bore hole. The results of the model are plotted for each axis as solid lines (Figure 8).

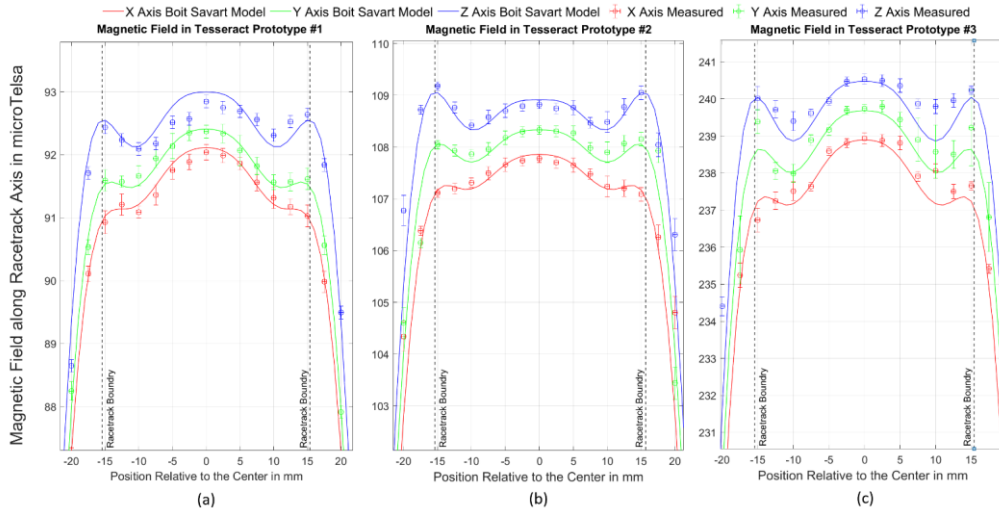

Figure 8: The measured values of the magnetic field for each position along the axis of the racetrack bore hole are plotted as circles with their corresponding error bars. The output Biot-Savart simulation at the location of the racetrack core is plotted as a solid line.

Slight differences between the field in the three axes are due to Tesseract’s different sized feedback loops that are necessary to nest the physical coils (Figure 1a). The simulation does a reasonable job of modeling the data within the error bars. To quantify the goodness of the model’s fit to the data, the square root of the variance of the residuals (RMSE) and the adjusted R-Squared values were calculated for each axis and for each of the three prototypes. The Biot-Savart model fits the data to well above an adjusted R-Squared value of 0.95 and an RMSE below 5.0 for each axis of each prototype sensor. The quality of these fits implies a very strong agreement between the data and the model, and we take this as an experimental validation of our Biot-Savart simulation.

3.2 Sensor Stability over Temperature

One of the main causes of fluxgate instability is the tendency of sensor’s intrinsic calibration parameters to change due to thermal variations in the sensor’s base and feedback windings (Acuna et al., 1978). The fluxgate sensor’s sensitivity and orthogonality have long been known to vary with sensor temperature (Trigg et al 1971). Thus, a characterization of the sensor’s sensitivity and orthogonality over the temperature range that would be expected on magnetospheric, or planetary mission is critical for the validation of a space-based fluxgate sensor.

The dominant effect of changes in temperature on a three-axis null sensor is the change in sensitivity due to variations in the geometry of the coils of wire used to provide magnetic feedback (Primdahl and Jensen, 1982) which is in turn dependent on the

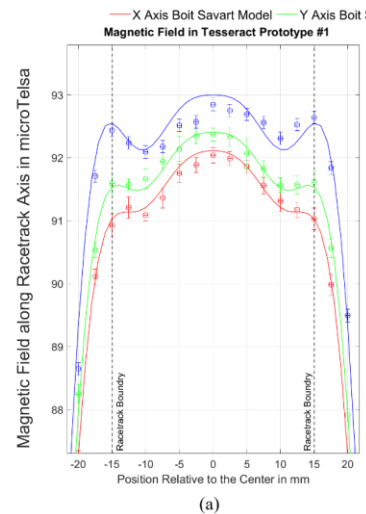

- Deleted:
- Deleted: Calibration
- Deleted: calibration
- Deleted: parameters

rate of thermal expansion or contraction of the material of the bobbin upon which the feedback coils are wound. (Acuña et al., 1978). The temperature dependent sensitivity can be corrected to first order by fluxgate electronics using compensated feedback current (Primdahl, 1970; Acuña et al., 1978; Miles et al., 2017). Another cause of instability is the tendency of the sensor's three orthogonal feedback coils to skew over changes in sensor temperature (Ripka, 1992); however, no equivalent compensation exists for orthogonality so while smaller temperature dependent sensitivity is desirable, smaller orthogonality dependence is more critical. Here, we describe a test to measure the sensitivity and orthogonality of the Tesseract sensor's feedback windings over temperature by temporarily configuring it as an air-core search coil magnetometer. This allows us to assess the temperature stability of sensor base and feedback windings without any dependence on cores or electronics.

415

420 3.2.1 Experimental Apparatus

Accurately measuring sensitivity and orthogonality over temperature is notoriously challenging, notably due to the difficulty of keeping the excitation/calibration coils thermally isolated from the sensor to ensure that measured changes result from the sensor under test rather than changes in the experimental apparatus. This test usually requires sophisticated equipment. Simpler, low-cost experimental setups have been created (i.e., Brauer et al., 1999; Miles et al., 2017) to calibrate a magnetometer using an insulated cooler filled with dry ice placed within some form of calibration coil.

425

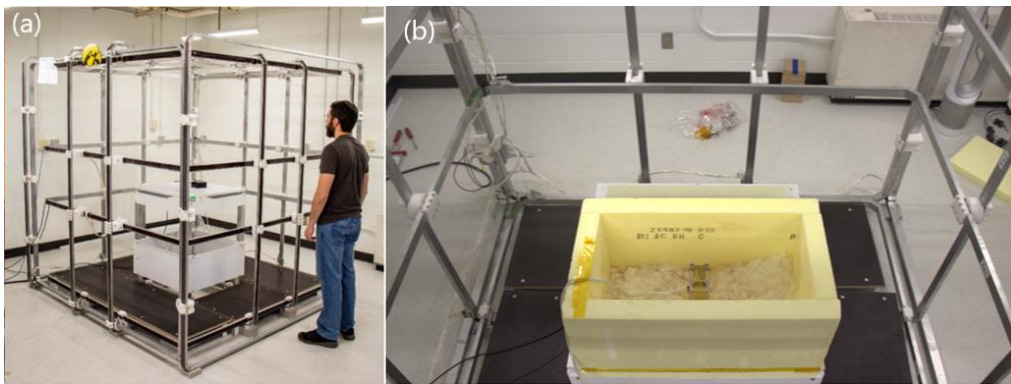

Figure 9: (a) The Tesseract prototype is secured in the center of a two-meter Merritt coil system. This coil system is used to generate a field against which the Tesseract can be calibrated. (b) The sensor is secured inside a polystyrene box and the box is filled with dry ice and a Styrofoam lid is placed on top.

430

To characterize the thermal stability of the Tesseract sensor's base and feedback windings without any dependence on cores and electronics, we temporarily configured it as an air-core search coil magnetometer. The sensor is placed in a thermally insulated box made from 10 cm thick polystyrene to create a controlled temperature environment for the sensor. The polystyrene box is then placed within the two-meter Merritt coil system shown in Figure 9a. The Tesseract sensor's axes are manually aligned with the coil system's axes (Figure 9b) and then slowly rotated until the measured 23 Hz signal is maximized in each axis. The sensor base is then firmly fastened to a mount, so that it does not rotate over the course of the test. The coil system was used to generate a 60,000 nT, AC magnetic field at 23 Hz in the x axis for 2 minutes. The same field is then applied on the Y and Z axes, and the coil system is set to cycle through X, Y and Z, so that a complete measurement of sensitivity and orthogonality is taken every 6 minutes. A reference vector magnetometer is placed outside of the box, aligned with the coil system, and wrapped in insulating material to monitor the applied AC field and ensure that the magnitude does not vary.

435

440

Deleted: s

Deleted: methods

Deleted: devised

Deleted: design

Deleted: to directly access the attributes of the sensor base and feedback windings without any dependence on cores or electronics.

Deleted: and fixed to the table so that

Deleted: 's

Deleted: with

Deleted: as shown in Figure 9a

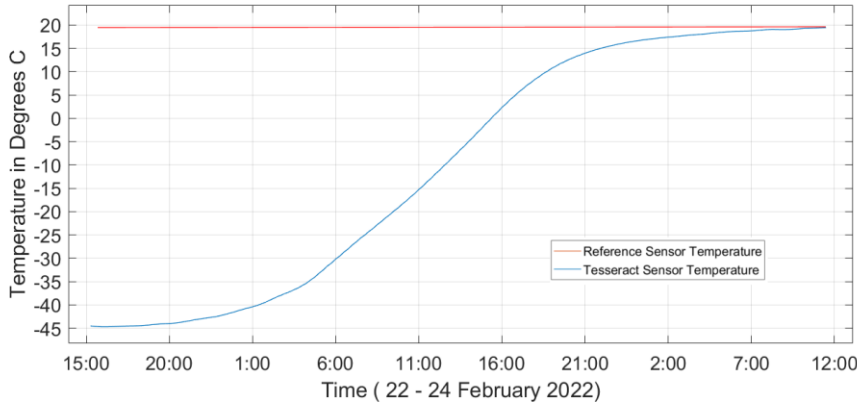

Figure 10: The temperature of the Tesseract sensor (blue) is measured using a platinum RTD as the dry ice sublimates. The temperature of the reference magnetometer (red) was also monitored and found to vary less than 0.1 C over the course of the test.

455 Ten pounds of dry ice is placed inside the box to chill the sensor, and measurements are taken after the dry ice has sublimated and the sensor is slowly warming. A platinum RTD temperature sensor is attached to the sensor and recorded the change in temperature as the sensor returned to room temperature (Figure 10). As the Tesseract sensor temperature slowly increased, the voltage induced in the Tesseract prototype sensor's feedback windings, the reference magnetometer and the temperature sensors are digitized and recorded using a common 18-bit National Instruments DAQ.

Deleted: response of the

460 3.2.2 Feedback Sensitivity and Orthogonality over Temperature

To evaluate the feedback sensitivity and orthogonality, a finite Fourier transform is performed for each 2-minute segment of data where the 23 Hz field is applied in X then Y then Z. The measured amplitudes of these signals at 23 Hz are recorded for all three axes. This yields nine values that define the calibration of the sensor.

Deleted: each

Deleted: axis

465 The sensitivity or gain on each axis is simply the output of the feedback winding when the 60,000 nT field is applied in that direction. Figure 12a plots the measured change in sensitivity measured in the X Y and Z feedback windings in parts per million over changes in temperature. The Tesseract sensor's three orthogonality angles; u_1, u_2 and u_3 , as defined in (Olsen et al., 2003) can be found using simple trigonometry:

Deleted: 1

Deleted: the angles between the X and Y axes, X and Z axes and Y and Z axis

Deleted: and are defined as

Formatted: Font color: Text 1

$$u_1 = \cos^{-1} \frac{Yy}{A} \quad (2)$$

$$u_2 = \sin^{-1} \frac{Zx}{A} \quad (3)$$

$$u_3 = \sin^{-1} \frac{Zy}{A} \quad (4)$$

470

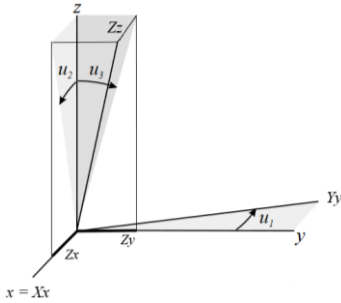

Figure 11: The orthogonality angles are defined in the convention from Olsen et al., 2003. The equations (2) (3) and (4) are different for u_1 because the Olsen et al. 2003 convention define the x axis to be projection invariant, the y axis has a single degree of freedom in the XY plane, and the z axis has two degrees of freedom.

Where Y_y is the field measured in the y axis when the coil system applies a field in y, Z_x is the field measured in x when a field is applied in z, and Z_y is the field measured in y when a field is applied in z. A is the total magnitude of the applied field which is defined as $A = \sqrt{Xx^2 + Yy^2 + Zz^2}$. Where Xx is the field measured in the x axis when the coil system applies a field in the x axis, Yy is the field measured in the y axis when the coil system applies a field to the y axis, and Zz is the measured field in the z axis when the coil system applies a field in the z axis. Figure 12b plots the change in these angles, u_1 , u_2 and u_3 , over temperature.

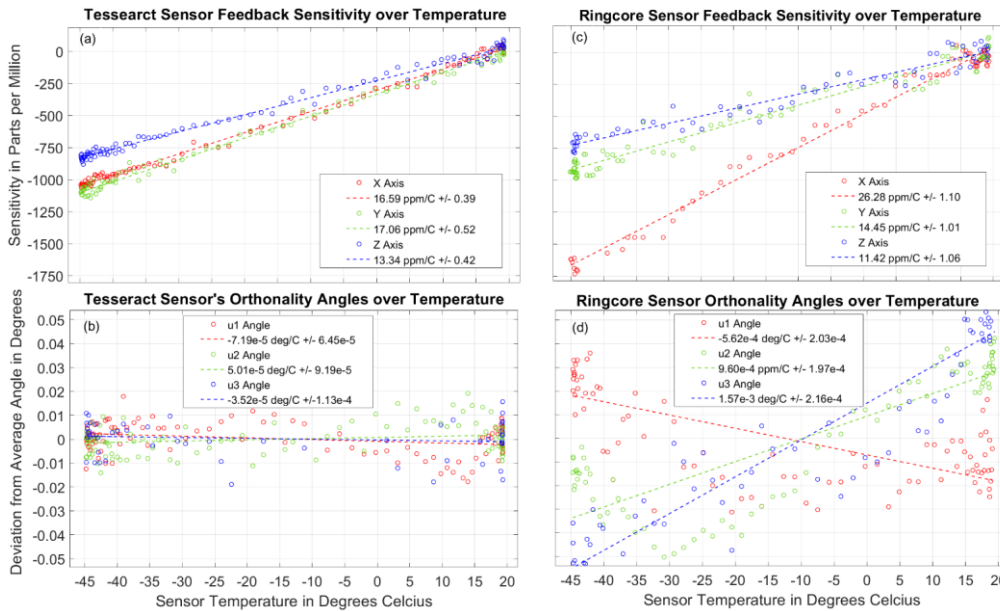
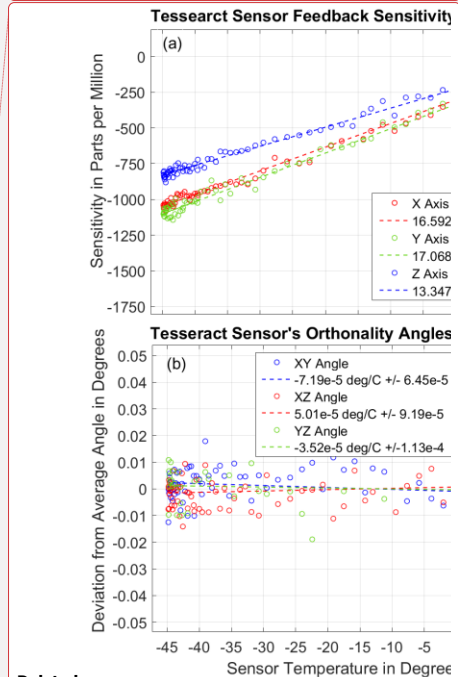

Figure 12: (a) The measured sensitivity of the Tesseract Sensor's three feedback windings plotted against temperature. Each circle is a two-minute measurement of the amplitude of the 60,000nT, 23 Hz signal. The dotted lines are a robust linear fit to the data. The fits estimate that the Tesseract's sensitivity over temperature. (b) The Tesseract sensor's three orthogonality angles: u_1 , u_2 and u_3 , plotted as a function of sensor temperature. None of the angles are found to unambiguously skew more than 0.015 degrees. (c) The measured sensitivity of the Miles (2013) ring-core sensor's three feedback winding plotted against temperature. (d) The Miles (2013) ring-core sensors' orthogonality angles are found to skew over temperature by as much as 0.09 degrees

Deleted: . F
 Deleted: figure
 Deleted: , Y_y is the field measured in the Y axis when the coil system applies a field to the Y axis,
 Deleted: 1
 Deleted: each of



Deleted:
 Deleted: 1
 Deleted: : u_1 , u_2 and u_3 , XY, XZ and YZ,

505

Notwithstanding this modest experimental setup, we are able to measure the sensor’s change in sensitivity and orthogonality over temperature. A robust linear fit to the data gives an estimate of the linear dependence of sensitivity on temperature. In all three axes, the sensitivities to temperature are very linear with R squared values of 0.995. We expect that this will make temperature compensation very effective, since the compensation method used by Acuña (1978) is strictly linear. The sensitivity to temperature in the X and Y axes is 16.6 ppm/°C and 17.1 ppm/°C respectively; very comparable to the thermal coefficient of expansion of copper (16.7 ppm/°C) and of the Torlon base material (16.2 ppm/°C) as predicted by Acuña et al., 1978. The Z axis, which is aligned with the direction that Torlon extrusion was injected into the mold during manufacturing, differs slightly (13.3 ppm/°C). Over the course of the test, the signal measured by the reference magnetometer does not vary more than 20 ppm in each axis which confirms that these changes in sensitivity are due to changes in the sensor’s feedback windings and not the applied field.

515

We do not measure any variation in axis alignment to within deviations of 0.015 degrees over changes in temperature from -45°C to 20°C. The sensor’s feedback windings are a less-than-ideal search coil, so the accuracy of the measurements is limited by poor signal. The background magnetic noise of the laboratory also limits the accuracy of this test. This test will be repeated once the sensor is integrated into a functioning fluxgate instrument in a magnetically quiet facility in order to verify its flight calibrations.

3.2.4 Comparison with Miles (2013) Ring-core Sensor Design

520

The sensitivity and orthogonality of the ring-core’s feedback windings over temperature were measured with the same method described above. The Miles (2013) ring-core sensor design (Figure 1b) was also temporarily configured as an air-core search coil magnetometer so that attributes of the sensor base and feedback windings could be directly measured. The measured sensitivity and orthogonality over temperature are plotted in Figure 12b and Figure 12d.

525

While the Tesseract and ring-core sensors have comparable thermal sensitivities, the Tesseract’s sensitivity over temperature is more consistent in each axis, presumably due to the greater symmetry of the sensor’s feedback windings. The ring-core sensors’ orthogonality angles skew by as much as 0.09 degrees (Figure 12d). The u_x Angle (blue) changes the most, presumably because the Miles (2013) ring-core sensor base is most asymmetric between the Y and Z Axes (Figure 1b).

3.3 Sensor Noise

530

The noise floor of a fluxgate is typically limited by the intrinsic magnetic noise of a ferromagnetic core that is periodically driven into magnetic saturation to modulate the local magnetic field. The noise floor on Tesseract’s custom miniature racetrack cores was characterized in Miles (2022). A single-axis electronics board was used to drive and sample each fluxgate core. The power spectral density noise floor of the instrument was estimated by using 20 minutes of data while the racetrack sensors were inside a single axis four-layer mumetal magnetic shield. The noise floor for the racetrack core sensors that will be used in Tesseract were determined to be 5 pT/√Hz at 1Hz (Miles et al., 2022).

535

4 Conclusions

540

The novel fluxgate sensor called Tesseract has been designed and prototyped. It is a low mass, low noise sensor that mitigates several known causes of instability in our 1” ring-core design. We modeled the sensor’s feedback winding using a Biot-Savart simulation and used it to optimize the Tesseract Sensor’s feedback topology for homogeneity and power consumption. The simulation results were in agreement with laboratory measurements of the prototype sensors’ feedback magnetic field. The Tesseract retains its ferromagnetic cores in a feedback magnetic field that homogeneous to within deviations of 0.42%

Deleted: the

Deleted: 1

Deleted: 1

Deleted: 1

Deleted: YZ

Deleted: the

We used a low-cost method to analyze the sensitivity and orthogonality of the sensor over temperature independent of cores or electronics. Using this method, we show that the Tesseract's three orthogonal axes skew by no more than 0.015 degrees over changes in temperature from -45 °C to 20 °C. The Tesseract sensor outperforms our 1" ring-core sensor design in both these metrics. The Tesseract's orthogonal axes are more stable by at least a factor of 4 and its magnetic feedback is more homogenous by a factor of 13. We surmise that the Tesseract sensor's higher degree of feedback homogeneity and axis stability over temperature will contribute to improved fluxgate stability.

Deleted: sensor's

Deleted: gain

Deleted: . This method uses coil system measurements and a second reference magnetometer sensitivity, orthogonality, of the sensor as a function of temperature.

Deleted: the traditional

555 4.1 Future Work

The accuracy of these measurements is limited by the magnetic noise of the laboratory setup and in an uncontrolled warming there is always the possibly for thermal gradients or transients. A more sophisticated experimental set up will be required to characterize the stability of Tesseract's calibration parameters to an accuracy acceptable for most space science applications (greater than ± 0.1 nT). We are currently developing a new calibration facility at the University of Iowa that will be purpose built for controlled temperature characterization, fluxgate sensor's calibration parameters which will incorporate better shielding and limit the possibly for thermal gradients or shocks. In future studies, we hope to use the specialized, environmentally controlled Helmholtz coil facility at Goddard Space Flight Center that would be capable of resolving Tesseract's long-term stability to a precision of ± 200 pT. (Vernier et al., 2004).

Deleted: ing

Deleted: over temperature.

Fluxgate electronics are currently being developed for the Tesseract Sensor in preparation for upcoming flights. Once the sensor has been integrated with cores and electronics, the Tesseract will be characterized again as a complete flight-ready fluxgate instrument. Tesseract will be flight demonstrated on the ACES-II sounding rockets, currently scheduled to launch in December 2022 and again aboard the TRACERS satellite mission as part of the MAGIC technology demonstration which is scheduled to launch in 2023.

570 Code and Data Availability

Data and source code used in the creation of this paper can be accessed by contacting the authors.

Author Contributions

K. Greene led the design, assembly, and execution of the experiments, analysed the data, created the feedback field simulation, and wrote the manuscript with contributions from all authors. D. M. Miles provided supervision and funding of the project as the lead investigator and assisted in the interpretation of the data. C. Hansen led the development and manufacture of the Tesseract Sensor prototypes. B. B. Narod conceptualized the Tesseract sensor design. R. Dvorsky assisted with the design of the sensor prototypes and testing apparatus.

580 Competing Interests

B. B. Narod operated Narod Geophysics Ltd., which manufactured fluxgate magnetometers until the company ceased production operation in 2008.

Acknowledgments

The authors are greatly indebted to Suman Sherwani and Amanda Lasko. This work would not have been possible if it were not for their oversight and management of the prototype manufacturing and testing processes. Special thanks to Samuel Hisel, Antonio

Washington and Alex Hoffman for lending their expertise to laboratory electronics and software, and for their flexibility in
595 managing hardware that made this experimental work feasible. Special thanks to Michael D Webb lending his expertise to
laboratory equipment. The authors would also like to thank Steve Klinkhammer and Ryan Helland for their manufacturing efforts
and Katherine Deasy for her work in configuration management.

Early development activities and much of the research infrastructure used in this work was supported by faculty start-up funding
600 for David Miles from the University of Iowa. This material is based upon work supported by the National Aeronautics and Space
Administration under Grant No. 80NSSC19K0491 issued through the Science Mission Directorate and Contract No.
80GSFC18C0008 administered by Goddard Space Flight Center

References

Acuña, M. H. and Ness, N. F.: The Magnetic Field of Saturn: Pioneer 11 Observations, *Science*, 207, 444–446,
605 <https://doi.org/10.1126/science.207.4429.444>, 1980.

Acuña, M. H., Searce, C. S., Seek, J., and Scheifele, J.: The MAGSAT vector magnetometer: A precision fluxgate magnetometer
for the measurement of the geomagnetic field, 1978.

610 Auster, H. U., Glassmeier, K. H., Magnes, W., Aydogar, O., Baumjohann, W., Constantinescu, D., Fischer, D., Fornacon, K. H.,
Georgescu, E., Harvey, P., Hillenmaier, O., Kroth, R., Ludlam, M., Narita, Y., Nakamura, R., Okrafka, K., Plaschke, F., Richter,
I., Schwarzl, H., Stoll, B., Valavanoglou, A., and Wiedemann, M.: The THEMIS Fluxgate Magnetometer, *Space Sci Rev*, 141,
235–264, <https://doi.org/10.1007/s11214-008-9365-9>, 2008.

615 Balogh, A., Carr, C. M., Acuña, M. H., Dunlop, M. W., Beek, T. J., Brown, P., Fornacon, K.-H., Georgescu, E., Glassmeier, K.-
H., Harris, J., Musmann, G., Oddy, T., and Schwingschuh, K.: The Cluster Magnetic Field Investigation: overview of in-flight
performance and initial results, *Ann. Geophys.*, 19, 1207–1217, <https://doi.org/10.5194/angeo-19-1207-2001>, 2001.

Bandyopadhyay, S., Subramanian, G. P., Foust, R., Morgan, D., Chung, S.-J., and Hadaegh, F.: A Review of Impending Small
620 Satellite Formation Flying Missions, in: 53rd AIAA Aerospace Sciences Meeting, 53rd AIAA Aerospace Sciences Meeting,
Kissimmee, Florida, <https://doi.org/10.2514/6.2015-1623>, 2015.

Brauer, P., Merayo, J. M. G., Risbo, T., and Primdahl, F.: Magnetic calibration of vector magnetometers, In Workshop on
Calibration of Space-Borne Magnetometers, Institute of Geophysics and Meteorology, Technical University of Braunschweig
625 March 9 1999.

[Brauer, P., Merayo, J. M. G., Nielsen, O. V., Primdahl, F., and Petersen, J. R.: Transverse field effect in fluxgate sensors, *Sensors and Actuators A: Physical*, 59, 70–74, \[https://doi.org/10.1016/S0924-4247\\(97\\)01416-7\]\(https://doi.org/10.1016/S0924-4247\(97\)01416-7\), 1997.](https://doi.org/10.1016/S0924-4247(97)01416-7)

630 [Chulliat A, Savary J, Telali A, Lalanne X: Acquisition of 1-Second Data in IPGP Magnetic Observatories. Proceedings of the XIIIth IAGA Workshop on Geomagnetic Observatory Instruments, Data Acquisition, and Processing: U.S. Geological Survey Open-File Report 2009-1226, 54-59 pp 2009.](#)

Forslund, Å., Belyayev, S., Ivchenko, N., Olsson, G., Edberg, T., and Marusenkov, A.: Miniaturized digital fluxgate magnetometer for small spacecraft applications, *Meas. Sci. Technol.*, 19, 015202, <https://doi.org/10.1088/0957-0233/19/1/015202>, 2008.

Ganushkina, N., Jaynes, A., and Liemohn, M.: Space Weather Effects Produced by the Ring Current Particles, *Space Sci Rev*, 212, 1315–1344, <https://doi.org/10.1007/s11214-017-0412-2>, 2017.

640 Garrick-Bethell, I., Paige, D. A., Burton, M., Boland, J., Abrahams, J. N. H., Bogert, C. van der, Choi, Y.-J., Deca, J., Hanna, K. D., Farrell, W. M., Hemingway, D., Hiesinger, H., Jin, H., Johnson, B. C., Kaluna, H., Kelley, M. R., Larson, D. E., Lawrence, D. J., Li, S., Ma, Y., Maxwell, R. E., Miller, R. S., Pieters, C. M., Poppe, A. R., Ravat, D., Russell, C. T., Siegler, M. A., Vernazza, P., and Weiss, B. P.: NanoSWARM: NanoSatellites for Space Weathering, Surface Water, Solar Wind, and Remanent Magnetism, 53, <https://doi.org/10.3847/25c2feb.314447c9>, 2021.

645 Grosz, A., Haji-Sheikh, M. J., and Mukhopadhyay, S. C. (Eds.): *High Sensitivity Magnetometers*, Springer International Publishing, Cham, <https://doi.org/10.1007/978-3-319-34070-8>, 2017.

Kepko, L., Clagett, C., Santos, L., Azimi, B., Berry, D., Bonalsky, T., Chai, D., Cudmore, A., Evans, A., Hesh, S., Jones, S., Marshall, J., Paschalidis, N., Rodriguez, J., Rodriguez, M., Sheikh, S., Starin, S., and Zesta, E.: Dellingr: NASA Goddard Space Flight Center's First 6U Spacecraft, 12, 2017.

[Korepanov, V. and Marusenkov, A.: Flux-Gate Magnetometers Design Peculiarities, *Surv Geophys.* 33, 1059–1079, <https://doi.org/10.1007/s10712-012-9197-8>, 2012.](#)

655 Magdaleno-Adame, S., Olivares-Galvan, J. C., Campero-Littlewood, E., Escarela-Perez, R., Blanco-Brisset, E.: COSMOL Conference, Boston, USA, July 5 Coil Systems to Generate Uniform Magnetic Field Volumes, 7, 2010.

660 Maruca, B. A., Agudelo Rueda, J. A., Bandyopadhyay, R., Bianco, F. B., Chasapis, A., Chhiber, R., DeWeese, H., Matthaues, W. H., Miles, D. M., Qudsi, R. A., Richardson, M. J., Servidio, S., Shay, M. A., Sundkvist, D., Verscharen, D., Vines, S. K., Westlake, J. H., and Wicks, R. T.: MagneToRE: Mapping the 3-D Magnetic Structure of the Solar Wind Using a Large Constellation of Nanosatellites, *Front. Astron. Space Sci.*, 8, 665885, <https://doi.org/10.3389/fspas.2021.665885>, 2021.

665 Merayo, JMG, Jørgensen JL, Friis-Christensen E, Brauer P, Primdahl F, Jørgensen PS, Allin TH, Denver T. The Swarm magnetometry package. In *Small satellites for Earth observation* (pp. 143-151). Springer, Dordrecht. 2008.

Merritt, R., Purcell, C., and Stroink, G.: Uniform magnetic field produced by three, four, and five square coils, *Review of Scientific Instruments*, 54, 879–882, <https://doi.org/10.1063/1.1137480>, 1983.

670 [Miles, D. M., Bennest, J. R., Mann, I. R., and Milling, D. K.: A radiation hardened digital fluxgate magnetometer for space applications, *Geosci. Instrum. Method. Data Syst.*, 2, 213–224, <https://doi.org/10.5194/gi-2-213-2013>, 2013.](https://doi.org/10.5194/gi-2-213-2013)

Miles, D. M., Mann, I. R., Ciurzynski, M., Barona, D., Narod, B. B., Bennest, J. R., Pakhotin, I. P., Kale, A., Bruner, B., Nokes, C. D. A., Cupido, C., Haluza-DeLay, T., Elliott, D. G., and Milling, D. K.: A miniature, low-power scientific fluxgate magnetometer: A stepping-stone to cube-satellite constellation missions: A Miniature Fluxgate Magnetometer, *J. Geophys. Res. Space Physics*, 121, 11,839–11,860, <https://doi.org/10.1002/2016JA023147>, 2016.

675 Miles, D. M., Mann, I. R., Kale, A., Milling, D. K., Narod, B. B., Bennest, J. R., Barona, D., and Unsworth, M. J.: The effect of winding and core support material on the thermal gain dependence of a fluxgate magnetometer sensor, *Geosci. Instrum. Method. Data Syst.*, 6, 377–396, <https://doi.org/10.5194/gi-6-377-2017>, 2017.

Miles, D. M., Ciurzynski, M., Barona, D., Narod, B. B., Bennest, J. R., Kale, A., Lessard, M., Milling, D. K., Larson, J., and Mann, I. R.: Low-noise permalloy ring cores for fluxgate magnetometers, *Geosci. Instrum. Method. Data Syst.*, 8, 227–240, <https://doi.org/10.5194/gi-8-227-2019>, 2019.

685 Miles, D. M., Dvorsky, R., Greene, K., Hansen, C. T., Narod, B. B., and Webb, M. D.: Contributors to fluxgate magnetic noise in permalloy foils including a potential new copper alloy regime, *Geosci. Instrum. Method. Data Syst.*, 11, 111–126, <https://doi.org/10.5194/gi-11-111-2022>, 2022.

690 Moldovanu, A., Chiriac, H., Moldovanu, C., Macoviciuc, M., and Ioan, C.: Performances of the fluxgate sensor with tensile stress annealed ribbons, *Sensors and Actuators A: Physical*, 81, 189–192, [https://doi.org/10.1016/S0924-4247\(99\)00085-0](https://doi.org/10.1016/S0924-4247(99)00085-0), 2000.

Nakariakov, V. M., Pilipenko, V., Heilig, B., Jelínek, P., Karlický, M., Klimushkin, D. Y., Kolotkov, D. Y., Lee, D.-H., Nisticò, G., Van Doorselaere, T., Verth, G., and Zimovets, I. V.: Magnetohydrodynamic Oscillations in the Solar Corona and Earth's Magnetosphere: Towards Consolidated Understanding, *Space Sci Rev*, 200, 75–203, <https://doi.org/10.1007/s11214-015-0233-0>, 2016.

Narod, B. B. and Bennest, J. R.: Ring-core fluxgate magnetometers for use as observatory variometers, *Physics of the Earth and Planetary Interiors*, 59, 23–28, [https://doi.org/10.1016/0031-9201\(90\)90205-C](https://doi.org/10.1016/0031-9201(90)90205-C), 1990.

700 [Olsen, N., Tøffner-Clausen, L., Sabaka, T. J., Brauer, P., Merayo, J. M. G., Jørgensen, J. L., Léger, J. M., Nielsen, O. V., Primdahl, F., and Risbo, T.: Calibration of the Ørsted vector magnetometer, *Earth Planet Sp.* 55, 11–18, <https://doi.org/10.1186/BF03352458>, 2003.](https://doi.org/10.1186/BF03352458)

705 [Petrucha, V., Janosek, M., and Azpurua, M. A.: Vector Feedback Homogeneity and Inner Layout Influence on Fluxgate Sensor Parameters, *IEEE Trans. Instrum. Meas.*, 64, 1285–1291, <https://doi.org/10.1109/TIM.2014.2362831>, 2015.](https://doi.org/10.1109/TIM.2014.2362831)

Pfaff, R. F., Jr.: An Overview of the Scientific and Space Weather Motivation for the Notional Geospace Dynamics Constellation Mission, AGU Fall Conference, San Francisco, CA, December 13, SA23C-01, 2016.

710

Primdahl, F.: Temperature compensation of fluxgate magnetometers, *IEEE Trans. Magn.*, 6, 819–822, <https://doi.org/10.1109/TMAG.1970.1066971>, 1970.

Primdahl, F.: The fluxgate magnetometer, *J. Phys. E: Sci. Instrum.*, 12, 241–253, <https://doi.org/10.1088/0022-3735/12/4/001>,

715 1979.

Primdahl, F. and Jensen, P. A.: Compact spherical coil for fluxgate magnetometer vector feedback, *J. Phys. E: Sci. Instrum.*, 15, 221–226, <https://doi.org/10.1088/0022-3735/15/2/015>, 1982.

720 Ripka, P.: Review of fluxgate sensors, *Sensors and Actuators A: Physical*, 33, 129–141, [https://doi.org/10.1016/0924-4247\(92\)80159-Z](https://doi.org/10.1016/0924-4247(92)80159-Z), 1992.

Ripka, P.: Advances in fluxgate sensors, *Sensors and Actuators A: Physical*, 106, 8–14, [https://doi.org/10.1016/S0924-4247\(03\)00094-3](https://doi.org/10.1016/S0924-4247(03)00094-3), 2003.

725

[Ripka, P. and Billingsley, S. W.: Crossfield effect at fluxgate. *Sensors and Actuators A: Physical*, 81, 176–179, https://doi.org/10.1016/S0924-4247\(99\)00082-5, 2000.](https://doi.org/10.1016/S0924-4247(99)00082-5)

[Ripka, P., Pribil, M., and Butta, M.: Fluxgate Offset Study, *IEEE Trans. Magn.*, 50, 1–4, https://doi.org/10.1109/TMAG.2014.2329777, 2014.](https://doi.org/10.1109/TMAG.2014.2329777)

730

Slavin, J. A., Le, G., Strangeway, R. J., Wang, Y., Boardsen, S. A., Moldwin, M. B., and Spence, H. E.: Space Technology 5 multi-point measurements of near-Earth magnetic fields: Initial results, *Geophys. Res. Lett.*, 35, L02107, <https://doi.org/10.1029/2007GL031728>, 2008.

735

Torbert, R. B., Russell, C. T., Magnes, W., Ergun, R. E., Lindqvist, P.-A., LeContel, O., Vaith, H., Macri, J., Myers, S., Rau, D., Needell, J., King, B., Granoff, M., Chutter, M., Dors, I., Olsson, G., Khotyaintsev, Y. V., Eriksson, A., Kletzing, C. A., Bounds, S., Anderson, B., Baumjohann, W., Steller, M., Bromund, K., Le, G., Nakamura, R., Strangeway, R. J., Leinweber, H. K., Tucker, S., Westfall, J., Fischer, D., Plaschke, F., Porter, J., and Lappalainen, K.: The *FIELDS* Instrument Suite on *MMS*: Scientific Objectives, Measurements, and Data Products, *Space Sci Rev*, 199, 105–135, <https://doi.org/10.1007/s11214-014-0109-8>, 2016.

740

Wallis, D. D., Miles, D. M., Narod, B. B., Bennet, J. R., Murphy, K. R., Mann, I. R., and Yau, A. W.: The *CASSIOPE/e-POP* Magnetic Field Instrument (MGF), *Space Sci Rev*, 189, 27–39, <https://doi.org/10.1007/s11214-014-0105-z>, 2015.